



# Pharos University in Alexandria



## The Sustainable Development Goals Report

2021-2022



## Table of Contents

	Content	Page
I.	<a href="#">Introduction</a>	5
II.	<a href="#">Involvement of Pharos University strategic Plan with UN-SDGs, Egypt-2030 and the national strategy of the Ministry of Higher Education and Research</a>	6
III.	<a href="#">Contribution of Pharos University to achieving SDGs of Relevancy</a>	11
SDG 1	<a href="#">No Poverty</a>	11
	<a href="#">No Poverty Events</a>	11
SDG 2	<a href="#">Zero Hunger</a>	15
	<a href="#">Zero Hunger Events</a>	15
SDG 3	<a href="#">Good Health and Well-Being</a>	18
	3.1 <a href="#">The Healthy Campus Initiative Campaign</a>	18
	3.2. <a href="#">Seminars, Conferences and Workshops</a>	19
	3.3 <a href="#">Good Health and Well-Being Activities</a>	27
	3.3.1 <a href="#">Vaccination Activities</a>	34
	3.4 <a href="#">Students' Community Projects in the Field of Health</a>	36
	3.5 <a href="#">Activities of Pharos University Clinics</a>	37
	3.6 <a href="#">MOUS for Students Training</a>	44
	3.7. <a href="#">Cooperation in Health Sector</a>	45
	3.8 <a href="#">Cooperation with Private Sector</a>	48
	3.9 <a href="#">Highlights on Research 2021</a>	50
	3.10 <a href="#">Courses in Curricula</a>	67
SDG 4	<a href="#">Quality Education</a>	70
	<a href="#">Quality Education Events</a>	70
SDG 5	<a href="#">Gender Equality</a>	92
	5.1 <a href="#">Statistics</a>	93
	5.2 <a href="#">Special Women Events</a>	93
	5.3 <a href="#">Women Mentoring Schemes</a>	96
	5.4 <a href="#">Scholarships</a>	99
	5.5 <a href="#">Conclusions and Appendix</a>	100
SDG 6	<a href="#">Clean Water and Sanitation</a>	101
	6.1 <a href="#">Pharos University Efforts</a>	101
	6.2 <a href="#">Courses in Curricula</a>	105
	6.3 <a href="#">Publications</a>	106



## Table of Contents (Cont.)

	Content	Page
SDG 7	<a href="#">Affordable and Clean Energy</a>	108
	7.1 <a href="#">Pharos University Efforts to Address Energy</a>	108
	7.2 <a href="#">Students' Projects</a>	108
	7.3 <a href="#">Courses in Curricula</a>	117
	7.4 <a href="#">Publications</a>	118
SDG 8	<a href="#">Decent Work + Economic Growth</a>	119
	8.1 <a href="#">Research on Economic Growth and Employment</a>	119
	8.2 <a href="#">Employment Practice</a>	119
	8.3 <a href="#">Employees</a>	123
	8.4 <a href="#">Proportion of Students taking Work Placements</a>	123
	8.5 <a href="#">Proportion of Employees on Secure Contracts</a>	125
	8.6 <a href="#">Courses in Curricula</a>	126
	8.7 <a href="#">Publications</a>	127
SDG 9	<a href="#">Industry Innovation and Infrastructure</a>	129
	9.1. <a href="#">Industry, Innovation and Infrastructure Events</a>	129
	9.2 <a href="#">Publications</a>	139
	9.3 <a href="#">Courses in Curricula</a>	141
SDG 10	<a href="#">Reduced Inequalities</a>	142
	10.1 <a href="#">Scholarships to Support Student in Need</a>	142
	10.2 <a href="#">Reduced Inequalities Activities</a>	144
	10.3 <a href="#">Students' Projects</a>	150
	10.4 <a href="#">Courses in Curricula</a>	152
SDG 11	<a href="#">Sustainable Cities and Communities</a>	153
	11.1 <a href="#">Conferences and Workshops</a>	153
	11.2 <a href="#">Activities</a>	155
	11.3 <a href="#">Publications</a>	160
	11.4 <a href="#">Courses in Curricula</a>	162
SDG 12	<a href="#">Responsible Consumption Production</a>	163
	12.1 <a href="#">Conferences and Workshops</a>	163
	12.2 <a href="#">Recycled Waste</a>	175
	12.3 <a href="#">Publications</a>	176
	12.4 <a href="#">Courses in Curricula</a>	185
SDG 13	<a href="#">Climate Action</a>	187
	13.1 <a href="#">Activities</a>	187
	13.2 <a href="#">Courses in Curricula</a>	193
SDG 14	<a href="#">Life Below Water</a>	194
	14.1 <a href="#">Activities and Events</a>	194
	14.2 <a href="#">Publications</a>	197



## Table of Contents (Cont.)

	Content	Page
SDG 15	<a href="#">Life on Land</a>	198
	15.1 <a href="#">Activities</a>	198
	15.2 <a href="#">Courses in Curricula</a>	200
SDG 16	<a href="#">Peace, Justice, and Strong Institutions</a>	201
	16.1 <a href="#">Seminars, Conferences and Workshops</a>	201
	16.2 <a href="#">Related Manuscripts</a>	203
	16.3 <a href="#">Courses in Curricula</a>	204
	16.4 <a href="#">International Cooperation</a>	204
	16.5 <a href="#">Publications</a>	205
SDG 17	<a href="#">Partnership for the Goals</a>	206
	17.1 <a href="#">National Cooperation for Implementation of SDGs</a>	206
	17.2 <a href="#">Cooperation for SDG 1</a>	209
	17.3 <a href="#">Cooperation for SDG 3</a>	210
	17.4 <a href="#">Cooperation for SDG 4</a>	218
	17.5 <a href="#">Cooperation for SDG 6</a>	220
	17.6 <a href="#">Cooperation for SDG 7</a>	222
	17.7 <a href="#">Cooperation for SDG 8</a>	223
	17.8 <a href="#">Cooperation for SDG 9</a>	224
	17.9 <a href="#">Cooperation for SDG 11</a>	227
	17.10 <a href="#">Cooperation for SDG 13</a>	236
	17.11 <a href="#">Cooperation for SDG 16</a>	239
	17.12 <a href="#">International Cooperation and Partnerships</a>	241
	17.13 <a href="#">General MOUs</a>	244
	17.14 <a href="#">Conferences</a>	246
	17.15 <a href="#">Partnerships for Sustainability</a>	249
	17.16 <a href="#">International Mobilities Contributing to Different SDGs</a>	255





## I. Introduction

At the 70th Session of the United Nations General Assembly in September 2015, member states adopted a new global development agenda, “Transforming our world: the 2030 Agenda for Sustainable Development”.

There are 17 development goals for sustainable development set out by the UN.

These goals were launched as a global agenda for addressing the multiplicity of social and environmental challenges that face communities.

All Sustainable development goals (SDGs) are increasingly integrated at all levels in universities, including its overall strategy.

Egypt has responded to the 17 SDGs by setting national plan: Egypt 2030 (<http://sdsegypt2030.com>). The third Pillar of this plan is on: Knowledge, Innovation and Scientific Research. which includes the following group of elements and components:

- General environment: Represents the role of the State in the creation of an environment that encourages innovation, including motivators and constraints, the economic system, policies, legislation, and principles of governance.
- Infrastructure: Play a fundamental role in supporting the cognitive and creative production by setting standards and laying regulatory foundations of innovation and scientific research, supporting business and innovation, protecting copyright, ensuring availability of information, financing and encouraging investment.
- Education and scientific research: Include all research organizations and institutions, technical education and vocational training institutions, higher education and scientific research institutions, and research centers.
- Industry: Represents all industrial sectors including large, medium, and small-scale companies’ activities relevant to research and development.
- Intermediaries: Includes the institutions that link industrial innovation, and research and development on the one hand, with academic and research institutions on the other hand.
- Development needs: Represents the required demand for innovation, knowledge, and scientific research to fulfill economic and social needs.



## II. Involvement of Pharos University Strategic Plan with UN-SDGs, Egypt-2030 and the National Strategy of the Ministry of Higher Education and Research

Pharos University has a direct involvement and input into the UN-SDGs, Egypt-2030 and the national strategy of the state ministry of Higher education and Research (Table 1). Development of the strategic goals of Pharos University meet the UN-SDGs and contribute to identify the national problems and challenges and enable adaptive management through its internal processes (rules and regulations), and external relationships (internationalization and partnerships <http://www.pua.edu.eg/international/international-partners/>).

**Table 1 The compliance of Pharos university Goals with the UN-SDGs**

Pharos University goal	Relation to UN-SDG
1. Raising the efficiency of the institutional capacity to improve competitiveness	GOAL 8: Decent Work and Economic Growth
2. Enhancing and supporting the educational system	GOAL 4: Quality Education GOAL 5: Gender Equality
3. Expanding the support to internationalization	Goal 17 Partnership to achieve the goals
4. Developing the scientific research system and post graduate studies to meet the national strategy	GOAL 4: Quality Education GOAL 5: Gender Equality
5. Expanding the activities of community services and environmental development	GOAL 11: Sustainable Cities and Communities
6. Raising the competitive skills of students	GOAL 4: Quality Education GOAL 5: Gender Equality

The strategic goals of Pharos University (<http://www.pua.edu.eg/about-pua/vision-and-mission/>) were reviewed and updated to meet the national strategies of sustainable development - Egypt 2030, Pillar 3: Objectives for the



knowledge, innovation, and scientific research to 2030

<http://sdsegypt2030.com/wp-content/uploads/2016/10/4.-Knowledge-Innovation-Scientific-Research-Pillar2.pdf>.

And in Arabic

<http://sdsegypt2030.com/wp-content/uploads/2016/05/%D8%A7%D9%84%D8%A7%D8%A8%D8%AA%D9%83%D8%A7%D8%B1.pdf>

Table 2. below indicates the direct involvement of pharos university in with the Sustainable development Strategy: Egypt 2030 (per objective) and the corresponding goals of Pharos University.

**Table 2. Involvement of Pharos University with Egypt 2030 strategy**

Objective for Knowledge, Innovation, and Scientific Research to 2030 (National SDG Plan)	Definition as indicated in the Sustainable development Strategy: Egypt 2030	Corresponding Pharos University Goal
Creation of a stimulating environment for the localization and production of knowledge	Maximizing knowledge production by enhancing the legislative, investment, and financing environments and providing the fundamental infrastructure	Goal 2. Enhancing and supporting the educational system Goal 1. Raising the efficiency of the institutional capacity to improve competitiveness
Activation and development of an integrated national innovation system	Enhancing the efficiency of innovation production by encouraging creative production, increasing the links between innovation and developmental needs, the development of basic education and higher education as well as research and development	Goal 4. Developing the scientific research system and post graduate studies to meet the national strategy Goal 6. Raising the competitive skills of students.
Linking the knowledge applications and the innovation outputs with priorities	Determining the sectorial priorities and challenges, how to address them by working on increasing the knowledge product for the priority sectors and by raising the local content	Goal 4 Developing the scientific research system and post graduate studies to meet the national strategy. Goal 5. Expanding the activities of community services and environmental development



The Ministry of Higher Education and Research has formulated its strategy to cope with EGYPT 2030 Plan. It is available in English in:

[http://portal.mohe.gov.eg/en-us/Documents/sr\\_strategy.pdf](http://portal.mohe.gov.eg/en-us/Documents/sr_strategy.pdf)

and in Arabic:

[http://portal.mohe.gov.eg/ar-eg/Documents/sr\\_strategy.pdf](http://portal.mohe.gov.eg/ar-eg/Documents/sr_strategy.pdf)

This strategy is basically summarized in improving 5 main aspects. These are

- Education
- Scientific research and Innovation
- Capacity building
- Community Services
- Health

Under the aspect of Scientific research and Innovation the following items are included:

1. Accessibility: education accessibility for all
2. Quality: Improvement of quality education system to be consistent and coping with international quality systems
3. Competitiveness: Improvement of outcomes of universities in a competitive manner (ranking)
4. Internationalization: Formulation of MOUs with international universities with the purpose of launching branching of these universities in Egypt, And establishment of joint research and educational programs.
5. Community services: Improvement of community services in the field of health

(University hospitals), Medical cohorts, cooperation with NGOs, and awareness activities to alleviate illiteracy and combat corruption

The goals of Pharos university are compliant with all the above items as one of the private universities that is recognized and accredited by the Ministry of higher education and research in Egypt. Table 3 shows the alignment of Pharos



University Goals with the goals of the Higher ministry of Education.

**Table 3. Alignment of Pharos University Goals with the goals of the Ministry of Higher Education**

Goals	Pharos University Goals	Goals of the Ministry of Higher Education
Goals 1.	Raising the efficiency of the institutional capacity to improve competitiveness.	Improvement of outcomes of universities in a competitive manner (ranking).
Goals 2.	Enhancing and supporting the educational system	Improvement of quality education system to be consistent and coping with international quality systems
Goal 3.	Expanding the support to internationalization	Internationalization: Formulation of MOUs with international universities with the purpose of launching branching of these universities in Egypt, And establishment of joint research and educational programs.
Goal 4.	Developing the scientific research system and post graduate studies to meet the national strategy	Improvement of outcomes of universities in a competitive manner (ranking)
Goal 5.	Expanding the activities of community services and environmental development	Improvement of community services in the field of health (university hospitals), Medical cohorts, cooperation with NGOs, and awareness activities to alleviate illiteracy and combat corruption
Goal 6.	Raising the competitive skills of students	education accessibility for all

Pharos University in Alexandria (PUA) is the only private university in Alexandria. Apart from the international research activities, PUA promotes youth development and foresees the empowerment of young generations to be entrepreneurs in a compressive manner. PUA also is concerned more with local issues and collaborates with local NGOs and Schools to contribute to achieving



SDGs. There have been several activities regionally and globally that adds to the SDGs that is either lightly covered or not covered in the previous report of 2018-2019.

The university recognizes and follows the articles in the national constitution that is relevant to SDGs 2014

[https://www.constituteproject.org/constitution/Egypt\\_2014.pdf](https://www.constituteproject.org/constitution/Egypt_2014.pdf) regarding achieving social justice and providing means of social independence (Article 8), ensuring equal opportunities for all citizens without discrimination (article 9), ensuring achievement of equality between men and women.

In all aspects (article 11), including appropriate representation of women, guaranteeing women's right of holding senior management offices in all sectors, and protect women against violence and enabling her to strike the balance between family duties and work requirements (article 11). Pharos University also has established an employments' insurance system that follows the social insurance system in a manner that guarantees a decent life (Article 17).

From the point of view of Pharos university, the 17 SDGs can be categorized into 4 categories.

1. Social wellbeing category including SDGs 1,2,3,4,5,8, 10, 16
2. Environmental Category including SDGs 6,7,12,13,14,15
3. Community advancement Category including SDGs 9,11
4. Outreach Category including SDG17

This report summaries the activities carried out by Pharos university in 2019-2020 to achieve the UN- SDGs. The activities take different forms; conferences for discussions, dialogues and exchange experience on SDG topics, community services by staff members form different departments, students' community Projects, identification of problems and research, and internal reports from departments. Each SDG is dealt with separately in the following sections of the report.



### III. Contribution of Pharos University to Achieving SDGs of Relevancy

#### SDG 1 – No Poverty

This Goal calls for an end to poverty in all its manifestations by 2030. It also aims to ensure social protection for the poor and vulnerable, increase access to basic services and support people harmed by other economic, social, and environmental disasters.

#### No Poverty Events

- **Pharos University Sends a Humanitarian Convoy to the Slum Areas of Alexandria**

In the framework of the endeavors of Pharos University to constantly engage in the community service activities, the PUA Community Service and Environmental Development Centre (CSED) sends a humanitarian aid convoy to Abees District, one of the slum areas in Alexandria Province, among others to deliver blankets to the needy families there. The coordination of this convoy is managed under the supervision of the officials in concern in the HQ of Alexandria Province. This is held on Friday, 31 January 2020.

URL: <https://www.pua.edu.eg/pharos-university-sends-a-humanitarian-convoy-to-the-slum-areas-of-alexandria/>

- **Pharos University Sent a Humanitarian Aid Convoy to Abees District in Alexandria**

In the light of the annual tradition of the PUA Community Service Council, the Student Activities Department organized a humanitarian aid convoy to deliver blankets to Abees District in Alexandria. The organization of this convoy was managed in coordination with the Ministry of Social Solidarity and Alexandria Governorate.







It is worth mentioning that many students from different faculties participated in this convoy. In addition to that, the convoy was accompanied by supervisors from the Security and Student Activities departments, Prof. Hesham El Shimy, the Student Activities Leader and Prof. Ramadan Abo El Ala, the PUA Vice President. Moreover, Dr. Jackline Azar, the Deputy Governor of Alexandria was keen to participate and follow up the proceedings of this convoy where she expressed her admiration for the university's activities in the field of community service and the students' behavior.

URL: <https://www.pua.edu.eg/pharos-university-sent-a-humanitarian-aid-convoy-to-abees-district-in-alexandria/>

- **Free Scholarships for Academic Year 2020-2021 المنح المجانية للعام الجامعي 2021/2020**

تعلن جامعة فاروس بالإسكندرية عن تقديم منح مجانية بكلية العلاج الطبيعي فقط طبقاً للحد الأدنى الموضوع:

كلية العلاج الطبيعي كحد أدنى للتقديم 97% بمجموع درجات 398 درجه سوف يتم فتح باب تلقي طلبات الراغبين في الحصول على المنح اعتباراً من 2020/09/27 وحتى 2020/10/01 وذلك من خلال البريد الإلكتروني Scholarship@pua.edu.eg

URL: [2021/2020 | المنح المجانية للعام الجامعي | Pharos University in Alexandria \(pua.edu.eg\)](https://www.pua.edu.eg/2021/2020-%D8%A7%D9%84%D9%85%D9%86%D9%87%D9%88%D9%89%D9%8A%D9%8B%D9%8C%D9%8D%D9%8E%D9%8F%D9%90%D9%91%D9%92%D9%93%D9%94%D9%95%D9%96%D9%97%D9%98%D9%99%D9%9A%D9%9B%D9%9C%D9%9D%D9%9E%D9%9F%D9%A0%D9%A1%D9%A2%D9%A3%D9%A4%D9%A5%D9%A6%D9%A7%D9%A8%D9%A9%D9%AA%D9%AB%D9%AC%D9%AD%D9%AE%D9%AF%D9%B0%D9%B1%D9%B2%D9%B3%D9%B4%D9%B5%D9%B6%D9%B7%D9%B8%D9%B9%D9%BA%D9%BB%D9%BC%D9%BD%D9%BE%D9%BF%D9%C0%D9%C1%D9%C2%D9%C3%D9%C4%D9%C5%D9%C6%D9%C7%D9%C8%D9%C9%D9%CA%D9%CB%D9%CC%D9%CD%D9%CE%D9%CF%D9%D0%D9%D1%D9%D2%D9%D3%D9%D4%D9%D5%D9%D6%D9%D7%D9%D8%D9%D9%D9%DA%D9%DB%D9%DC%D9%DD%D9%DE%D9%DF%D9%E0%D9%E1%D9%E2%D9%E3%D9%E4%D9%E5%D9%E6%D9%E7%D9%E8%D9%E9%D9%EA%D9%EB%D9%EC%D9%ED%D9%EE%D9%EF%D9%F0%D9%F1%D9%F2%D9%F3%D9%F4%D9%F5%D9%F6%D9%F7%D9%F8%D9%F9%D9%FA%D9%FB%D9%FC%D9%FD%D9%FE%D9%FF)

- **Pharos University Celebrated Orphans Day**

The students and faculty members of PUA celebrated Orphans Day. The coordination was made between the Community Services and Environment Development Affairs and six charities. The ceremony was held at those charities. On 9th and 10th of April 2021, PUA formed six groups comprised of students, faculty members and coordinators of the student activities to visit those charities and give the orphans toys, gifts and clothes that had a good impact on children and staff. This activity is a part of the university's keenness to activate its role in developing the spiritual, moral and loyalty values of students as well as participating in community service. It is worth mentioning that the students were excited and happy for participating in this charity work. The visits were divided as following:





### On Friday, 9 April 2021:

- “Tarek ElKhair” Community Service, Sidi Gaber.
- “Al mutadarieun” Community Service, Rabaa El Nasria, Abis.
  - “El Qalaa” Community Service, Awayed.
- “Kfalet El Yatem” Community Service, Ezbet Fathi.

### On Saturday, 10 April 2021:

- “Nabaa El Hop” Community Service, El Hadra El Gadida.
- “El Estqrar” Community Service, Zawya Abd El-Qader, Al Amaria.



URL: [Pharos University Celebrated Orphans Day | Pharos University in Alexandria \(pua.edu.eg\)](http://Pharos University Celebrated Orphans Day | Pharos University in Alexandria (pua.edu.eg))

- **Qawafel Al Khair Drive off PUA**

In continuation of the annual tradition accustomed by Pharos University management and implemented and followed-up by the Board of Trustees headed by Eng. Alaa Ragab, Chairman of the Board of Trustees, 7 charitable convoys (Qawafel Al Khair) were dispatched to several areas in Alexandria. The convoys included student activities supervisors, some faculty members, and



many students, who participated in this charitable work with great enthusiasm. In addition to the participation and supervision of Prof. Dr. Ramadan Abu El-Ala, Vice President of the University for Community Service and Environmental Development.



The convoys covered the areas of Bahri, Souk al-Turk (Ras Al Tin Society), Abis (Al Mutadaroon Society) and (Mujib al-Sayyelin Society), Al Hadra Al Gadida, Zohour Street (Naba'a Al Hob Society), Sidi Gaber (Tariq Al Khair Society), Al Awayed (Al-Qalaa Society), and Al-Amiriya (Al Istikrar Society). This activity comes within the framework of the administration's keenness to implement its role in developing the students' spiritual and moral values. In addition to promoting the value of loyalty, sense of belonging, and societal involvement, which all were clearly reflected through the students' enthusiasm to participate, and their happiness in performing these charitable works.

URL: [Qawafel Al Khair Drive off of PUA | Pharos University in Alexandria](#)



## SDG 2 – Zero Hunger

The ability to feed the world is a key element of sustainable development. If done right, agriculture, forestry and fisheries can provide nutritious food for all. At the same time, it can ensure rural development with people at the center of the process, supporting the incomes of those who rely on agriculture.

Universities need to be able to demonstrate how they are contributing to end hunger, achieve food security and improve nutrition and promote sustainable agriculture.

### Zero Hunger Events

- Faculty of Legal Studies' Charity Market

As part of the student activities, the Faculty of Legal Studies organized a charity market to distribute Ramadan supplies to the workers free of charge. The market that took place on Wednesday, April 20, 2022 at 1:00 pm, was opened by Prof. Dr. Ramadan Abu El Ala, Vice President for Community Service and Environmental Development, and Prof. Dr. Hammam Zahran, Dean of the Faculty of Legal Studies. Further, it was attended by a group of faculty members and teaching assistants, along with many students.



URL: <https://www.pua.edu.eg/faculty-of-legal-studies-charity-market/>

- Qawafel Al Khair Drive off of PUA

In continuation of the annual tradition accustomed by Pharos University management and implemented and followed-up by the Board of Trustees headed by Eng. Alaa Ragab, Chairman of the Board of Trustees, 7 charitable





convoys (Qawafel Al Khair) were dispatched to several areas in Alexandria. The convoys included student activities supervisors, some faculty members, and many students, who participated in this charitable work with great enthusiasm. In addition to the participation and supervision of Prof. Dr. Ramadan Abu El-Ala, Vice President of the University for Community Service and Environmental Development.



The convoys covered the areas of Bahri, Souk al-Turk (Ras Al Tin Society), Abis (Al Mutadaroon Society) and (Mujib al-Sayyelin Society), Al Hadra Al Gadida, Zohour Street (Naba'a Al Hob Society), Sidi Gaber (Tariq Al Khair Society), Al Awayed (Al-Qalaa Society), and Al-Amiriya (Al Istikrar Society). This activity comes within the framework of the administration's keenness to implement its role in developing the students' spiritual and moral values. In addition to promoting the value of loyalty, sense of belonging, and societal involvement, which all were clearly reflected through the students' enthusiasm to participate, and their happiness in performing these charitable works.

URL: [Qawafel Al Khair Drive off of PUA | Pharos University in Alexandria](#)

- **Pharos University Celebrated Orphans Day**

The students and faculty members of PUA celebrated Orphans Day. The coordination was made between the Community Services and Environment Development Affairs and six charities. The ceremony was held at those charities. On 9th and 10th of April 2021, PUA formed six groups comprised of students, faculty members and coordinators of the student activities to visit those charities and give the orphans toys, gifts and clothes that had a good impact on children and staff. This activity is a part of the university's keenness to activate its role in developing the spiritual, moral and loyalty values of students as well as participating in community service. It is worth mentioning that the students were



excited and happy for participating in this charity work. The visits were divided as following:

**On Friday, 9 April 2021:**

- “Tarek ElKhair” Community Service, Sidi Gaber.
- “Al mutadarieun” Community Service, Rabaa El Nasria, Abis.
- “El Qalaa” Community Service, Awayed.
- “Kfalet El Yatem” Community Service, Ezbet Fathi.

**On Saturday, 10 April 2021:**

- “Nabaa El Hop” Community Service, El Hadra El Gadida.
- “El Estqrar” Community Service, Zawya Abd El-Qader, Al Amaria.



URL: [Pharos University Celebrated Orphans Day | Pharos University in Alexandria \(pua.edu.eg\)](https://pua.edu.eg)



## SDG 3 – Good Health and Well-Being

Major progress has been made in improving the health of millions of people, increasing life expectancy, reducing maternal and child mortality, and fighting against leading communicable diseases. Concerted efforts are required to achieve universal health coverage and sustainable financing for health, to address the growing burden of non-communicable diseases, including mental health, and to tackle antimicrobial resistance and determinants of health such as air pollution and inadequate water and sanitation.

Pharos University has records contributing to SDG3 in several aspects including aid convoys, health initiatives, conferences and seminars, activities of Pharos university clinics, local national and international cooperation, and international research publications. Below is a summary of Pharos University achievements in the health sector.

### 3.1 The Healthy Campus Initiative Campaign

- The Faculty of Arts and Media Blood Donation Campaign

The Faculty of Arts and Media in collaboration with the Faculties of Legal Studies, Engineering, Pharmacy and Dentistry organized a blood donation campaign on Tuesday, March 15th, 2022. The event was organized within the framework of PUA's participation in community service activities.

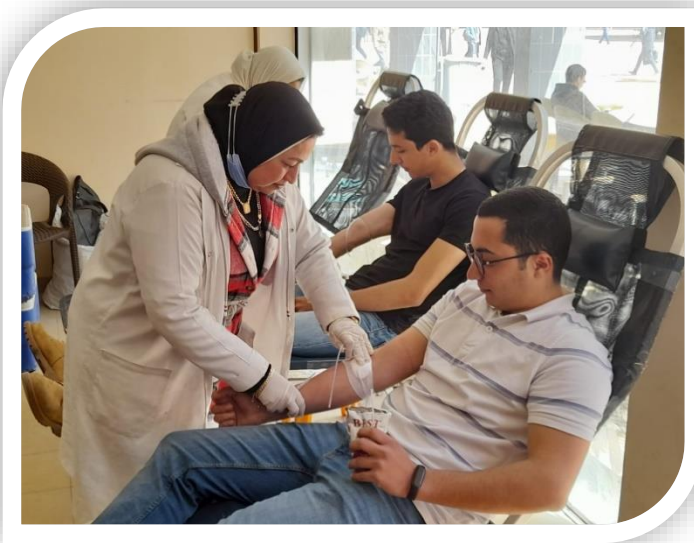

The event started at 11 am with the arrival of a blood donation vehicle from the Blood Bank. The campaign was met with an overwhelming turnout of students, while the faculties cooperated in organization and motivation of the students.

<https://www.pua.edu.eg/%d9%83%d9%84%d9%8a%d8%a9-%d8%a7%d9%84%d9%81%d9%86%d9%88%d9%86-%d9%88%d8%a7%d9%84%d8%aa%d8%b5%d9%85%d9%8a%d9%85->



[%d8%aa%d9%86%d8%b8%d9%85-%d8%ad%d9%85%d9%84%d8%a9-%d9%84%d9%84%d8%aa%d8%a8%d8%b1%d8%b9/](#)

### 3.2 Seminars, Conferences and Workshops

- The faculty of Dentistry participated in the Egyptian Dental Exhibition (EDE 2020) on Thursday, 13 February 2020 in at Cairo International Convention Centre (CICC). The trip aimed at apprising the PUA delegation which included several faculty members, teaching assistants and students of different academic years of the state-of-the art equipment and technology in general and in the field of dentistry in particular.



<https://www.pua.edu.eg/the-faculty-of-dentistry-organized-a-trip-to-the-egyptian-dental-exhibition/>

- The Faculty of Pharmacy and Drug Manufacturing at Pharos University organized a symposium entitled “OTC from A to Z” on 7 March 2020. The lecture was delivered by Dr. Magdy Shalash, the Director of El Taybey Academy for Pharmaceutical Training and Dr. Sally Ibrahim, the Head OTC Department at El Taybey Academy for Pharmaceutical Training. It is worth mentioning that the symposium discussed the following points: How the pharmacist deals with different cases of chronic Arthritis? How to dispense medicines without medical prescription and what are these OTC drugs? What are the cases that should be directly referred to a physician not a pharmacist?

["OTC from A to Z" Symposium | Pharos University in Alexandria \(pua.edu.eg\)](#)





- The Faculty of Health and Applied Science Technology organized a seminar entitled “Significance of a Vegetarian Diet on Health and Environment” on Tuesday 19/4/2022. The seminar was held under the supervision of Prof. Dr. Ezzat Hassan, Dean of the Faculty of Health and Applied Science Technology, and Prof. Dr. Hamdy Al-Wakeel, Vice Dean for Education and Student Affairs, and in the presence of several Faculty students. This event was held as part of the activities of the Scientific Committee of Student Activities Department. Dr. Duha Abu Zahra and students/ Muhammad Essam and Nada Hamida participated in the seminar by making a poster on the food pyramid for vegetarians. Students/ Rodina Adly and Sandy Mohamed also participated by explaining the benefits and harms of vegetarian diet.

<https://www.pua.edu.eg/significance-of-a-vegetarian-diet-on-health-and-environment-seminar/>





• The Faculty of Pharmacy held its biannual Conference on Pharmacology at 11 and 12th March 2020. The conference was carried out under the auspices of the president of the university and is supported by several pharmaceutical companies and AUF agency of France. The conference was attended by about 300 expert and researcher, where 102 scientific papers were presented, and published in the conference booklet after being reviewed. International attendees were from France, Finland, Sweden, and Canada. Selected scientific presentations in the conference included:

- Sustainable Development in Pharmacy Education and Practice.
- Biosimilar Medicines.
- Pharmacoeconomics: Cost analysis of clinical pharmacy interventions.
- Pharmacovigilance: Case Safety report.
- A Path from Academic to Innovation in Pharmaceutical Industries.
- Nanotechnology: Current Trends and Future Perspective.
- Challenges in Novel Drug Delivery Systems.
- New Aspects of Natural Products in Drug Discovery.
- Immunotherapy, Genetics and Pharmaceutical Biotechnology.
- Infection Prevention and Control.
- Computer Aided Drug Design and Synthesis.
- Bioanalytical Chemistry.
- The Road from Pharmaceutical Sciences to Patient Care Approach.
- Evidence – Based Pharmaceutical Care.
- New Perspectives and Advances in Pharmacotherapy (Cardiovascular, Nephrology, Gastroenterology, Endocrinology, Respiratory System, Neurology and Neurodegenerative Diseases).

<https://www.pua.edu.eg/icmaps/>

• The Faculty of Applied Health Sciences Technology organized a symposium



to raise the awareness of coronavirus on Tuesday,10 March 2020. The symposium was delivered by Dr. Mohamed Salah EIDin, an Assistant Professor of Biochemistry, and Immunity in the Medical Laboratory Department. The symposium explained the modes of the coronavirus transmission, its symptoms, and methods of protection.

<https://www.pua.edu.eg/the-faculty-of-applied-health-sciences-technology-organized-a-symposium-about-coronavirus/>





- The First student conference of the faculty entitled “Role of Allied Medical Sciences in the Achievement of Sustainable Development” on Blackboard platform. This was held on Tuesday, 5 January 2021. This conference was attended by 23 students from different departments. The participating students gave a synopsis about the sustainable development goals and the effect of COVID 19 Pandemic on the progress made to reach those goals. During the conference, they discussed the role of Epidemiology, nutrition, infection control, medical informatics, and biophysics in achieving the sustainable development goals.

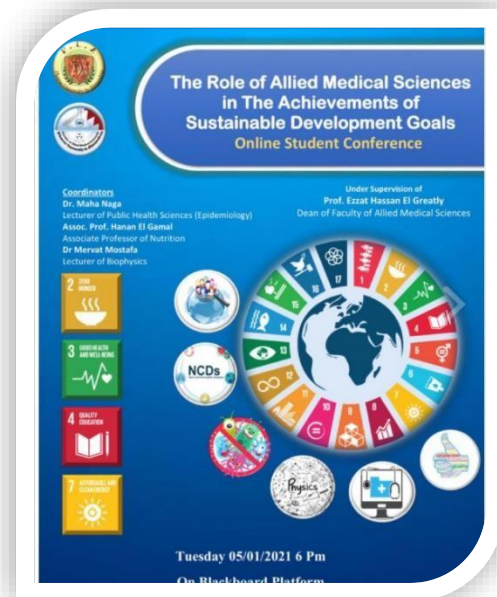

<https://www.pua.edu.eg/the-first-student-conference-entitled-role-of-allied-medical-sciences-in-the-achievement-of-sustainable-development/>

- A seminar entitled “Bright Side of COVID-19 Pandemic” was organized on Thursday, 24 December 2020 using Blackboard platform. The seminar was delivered by Dr. Heba Al Shehi, a Lecturer in the Nutrition and Food Safety Technology Department who discussed with the students the positive side of COVID-19 pandemic as well as the consequences of quarantine and its effect on the environment, personal hygiene, nutrition, and relationships. Moreover, she explained that every subject has two points of view, one positive and the other negative depending on how we see it. It is worth mentioning that COVID-19 and quarantine have closed factories, stopped gatherings, and banned travel but on the bright side it has positive impact such as:
  - Reduced air and water pollution.
  - People benefited from quarantine in taking self-improvement sessions.
  - Reducing the consumption of fast food and the transformation to e-stores and home delivery to reduce gatherings.
  - Schools and universities tend to e-learning.

<https://www.pua.edu.eg/bright-side-of-covid-19-pandemic/>

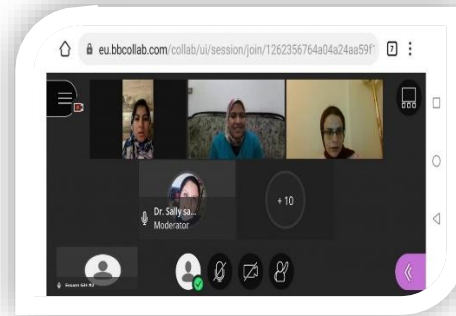

- The Faculty of Applied Health Sciences Technology held a scientific competition entitled “Obesity and Covid-19”. It was organized on Thursday, 14 January 2021 online on Blackboard platform. The participating students were divided into 5 groups consisting of 6 students and each group prepared a presentation on obesity and Covid-19 by defining obesity, its damages, its relationship to Covid-19, and how the risk of developing it can be avoided by changing the negative lifestyle. At the end of the competition, the judging panel evaluated the presentations based on the scientific content, PowerPoint design and presentation skills.

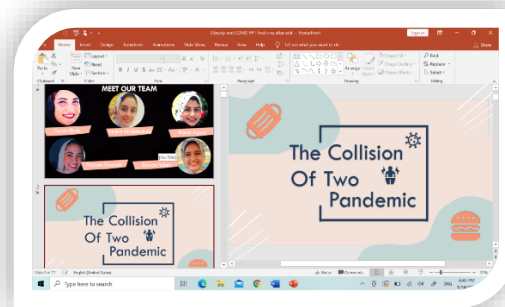

<https://www.pua.edu.eg/the-faculty-of-applied-health-sciences-technology-organized-a-scientific-competition-entitled-obesity-and-covid-19/>

- The Faculty of Applied Health Sciences Technology held an online seminar entitled “Reasons that Can Impede Weight-Loss” on Blackboard Platform. The seminar was delivered by Dr. Sally Salah, a Lecturer in the Nutrition and Food Safety Technology Department on Tuesday, 5 January 2021. The seminar discussed the reasons for the failure of weight-loss diets, the proposed solutions to overcome those barriers and how to make any healthy weight-loss diet work. Moreover, Dr. Doha Magdy, Dr. Nermine Khamis and Dr. Heba El Shehy, Lecturers in the Nutrition and Food Safety Technology Department had an open discussion with participating students, learning about their different experiences in following different types of diets, answering their inquiries, and providing several tips to improve the results of these diets.



<https://www.pua.edu.eg/the-faculty-of-applied-health-sciences-technology-organized-seminar-entitled-reasons-that-can-impede-weight-loss/>



- The Faculty of Applied Health Sciences Technology organized an online symposium entitled “The Risks of Anesthesia between Reality and Illusion” using Zoom application on Thursday, 17 December 2020. The symposium was delivered by Dr. Enas

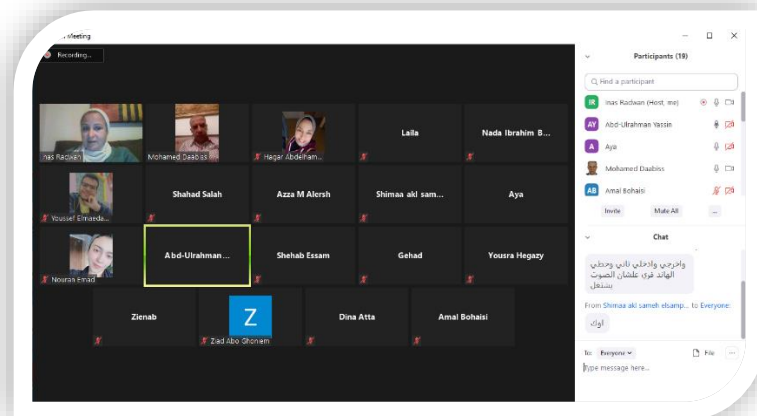

Abd Elmoneim and Dr. Mohamed Ali Daabis, Lecturers in the Critical Care and Anesthesia Technology Department. The symposium discussed the risks of anesthesia to which the patient or medical staff may be exposed. Moreover, different potential problems were also presented and discussed by the attendees, e.g. how to avoid health problems, appropriate solutions evaluating the scale of health risks and society awareness on sound scientific grounds. The symposium was attended by several students who asked a lot of questions and gave their opinions about the topics discussed.

<https://www.pua.edu.eg/the-faculty-of-applied-health-sciences-technology-organized-a-symposium-entitled-the-risks-of-anesthesia-between-reality-and-illusion/>

- The Faculty of Applied Health Sciences Technology organized a symposium entitled “Iron Deficiency anemia a global and regional perspective- Egypt” given





by Dr. Amany Salama, a Lecturer in the Nutrition Department. The symposium was held on Tuesday, 1 December 2020. This symposium covered the causes of anemia, and the commonest cause is iron deficiency as well as other causes such as:

- Acute and chronic infections that result in inflammation and hemorrhages.
- Deficiencies of other vitamins and minerals especially folate, vitamin B12 and vitamin A.
- Genetically inherited traits such as thalassemia.

<https://www.pua.edu.eg/the-faculty-of-applied-health-sciences-technology-organized-a-symposium-entitled-iron-deficiency-anemia-a-global-and-regional-perspective-egypt/>

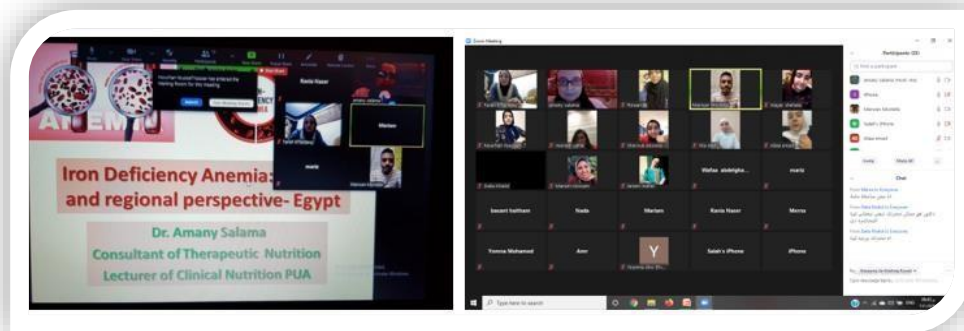

- The faculty of Pharmacy and Drugs Manufacturing received Dr. Manal Abu ELfadl, in the presence of Dr. Sameh Younis- the Pioneer of the student activities and the representatives of EVA Pharma to discuss the continuous cooperation in Nutrition and Health field in general. Dr. Manal Abu ELfadl talked about the importance of healthy food and its result in the long term and short then, the various types of healthy diets were presented. This was followed by having the representatives of the company measured the fats percentage, muscles, water, and metabolism rate in body for the students and university staff by using InBody devices.

<https://www.pua.edu.eg/health-care-and-nutrition/>



### 3.3 Good Health and Well-Being Activities

- Within the framework of its plan for community service and environmental development, PUA has adopted dispatching several medical convoys periodically at 5/4/2022 under the supervision of Prof. Ramadan Abu El-Ala, President of Community Service & Environment Development Affairs. Accordingly, a medical convoy was prepared for a nursing home in Al Ras Al-Souda, in cooperation between the Faculty of Dentistry and the Faculty of Applied Health Sciences Technology. Further, an agreement was reached with the home's officials to transfer the elderly women to the Faculty of Dentistry, Pharos University by a bus provided by the home to receive the necessary service and carefree of charge. Physicians from the Faculty of Health Sciences Technology from the Department of Nutrition, Medical Laboratories, Dental Prosthesis, and some resident doctors conducted nutritional health education for the home residents, a nutritional screening, and provided some health tips and instructions for the kitchen staff. At the end of the visit, gifts were presented to the residents of the home in a family atmosphere.



<https://www.pua.edu.eg/medical-convoy-for-a-nursing-home-in-al-ras-al-souda/>



- In the framework of the summer training 2020-2021, the Department of Architectural Engineering participated with a group of students from the Fourth Level (8th Semester): Aisha Mohamed, Nadine Hisham and Sarah Al



Murabai, under the supervision of Associate Prof. Riham Nady Faragallah and the team won the First Prize (People and Jurors Choice Award). The main aim of the competition is to design a sustainable and healthy environment that meets all the needs of pilgrims through functional design of small spaces and upgrading their experience in the light of the increasing number of pilgrims in the city of Mina, Saudi Arabia. It considers the precautionary and hygienic measures to confront COVID-19, as well as applying various environmental treatments that are compatible with this desert area. In this way, the tents in the city of Mina are ready for the growth of pilgrims in the future. The Saudi office INJ Architects, in cooperation with UNI Competitions, launched an International Architectural Competition entitled: "The White Lands", in which a large group of architectural offices, architects and architectural students have participated from 23 different countries around the world. Jury Comments: Good concept with reference to the "Tent" legacy of Mina, allowing for future growth and challenges of any health threatening issues (like the current COVID-19) with good health, hygiene and distancing measures.

<https://www.pua.edu.eg/a-sustainable-and-healthy-tent-for-pilgrims/>

- The Faculty of Applied Health Sciences Technology and Dr. Mohamed El Safawany, a Lecturer in diagnostic radiology, the faculty organized a training visit for fourth year students in Ayadi al Mostakbal Hospital in Alexandria. This trip was held on the 3rd and 4th of November 2020. During the visit the students used the atomic scanners and visited radioactive materials preparation laboratories. This visit was managed under the supervision of Prof. Omar Shebl Zahra, Professor of Oncology and Nuclear Medicine and an adjust Lecturer in the Radiological Sciences and Medical Imaging Department and the Former Head of the Nuclear





Medicine Department in Ayadi al Mostakbal Hospital, Mr. Magdy Aly and Mr. Mohamed Zakria Assistant Lecturers, Demonstrator Hanan Ahmed.

<https://www.pua.edu.eg/the-faculty-of-applied-health-sciences-technology-organized-a-visit-to-ayadi-al-mostakbal-hospital/>



- The Medical Equipment Department, of the Faculty of Applied Health Sciences Technology participated in “Egypt Make Electronics” Innovation funded by ITEDA and the Ministry of Communications and Information Technology. This was held on Saturday, 21 November 2020. A number of third- and fourth-year students, faculty members and teaching assistants visited EME Innovation Hub-Borg to be acquainted with the available facilities and gave the students ideas for their graduation projects. Moreover, they attended the closing ceremony of the “Egypt IoT and AI challenge 2020” competition.

<https://www.pua.edu.eg/the-medical-equipment-department-participated-in-egypt-make-electronics-innovation/>



- On Tuesday, March 08, 2022, the Faculty of Computer Science and



Artificial Intelligence organized a sports day for its students. The day witnessed a strong participation from students, faculty members, and teaching assistants. They participated in sports activities such as football, basketball, and table tennis. In addition to physical activities, Zumba, and various games, in cooperation with Gold's Gym. At the end of the day, medals were given to the winning students, and pictures of the day's activities were taken.

<https://www.pua.edu.eg/faculty-of-computer-sciences-and-artificial-intelligences-sports-day/>



- Under the supervision of the Activities Department, the Architecture Department of the Faculty of Engineering organized a sports day on 29/5/2022 for the department students. The day included two football tournaments, as well as Basketball, Volleyball, Table Tennis, and many other recreational games. Further, many faculty members participated with their students in this sports day held on Pharos University playgrounds to support and encourage them to move forward in their athletic excellence as well as their scientific excellence.



<https://www.pua.edu.eg/%d8%a7%d9%84%d9%8a%d9%88%d9%85-%d8%a7%d9%84%d8%b1%d9%8a%d8%a7%d8%b6%d9%8a-%d9%84%d9%82%d8%b3%d9%85-%d8%a7%d9%84%d8%b9%d9%85%d8%a7%d8%b1%d8%a9-%d8%a8%d9%83%d9%84%d9%8a%d8%a9-%d8%a7%d9%84%d9%87%d9%86/>

- Students of Medical Equipment Maintenance Department have won the third place in the “Pandemic TechHack –Egypt 2020” Competition out of 40 participating ideas which was held on Tuesday, 15 April 2020. The competition is



a part of “The Egyptian Virtual Hackathon Against Coronavirus” which is a national initiative to unite efforts and resources using technology and science to:

- Confront the epidemic.
- Help reduce the spread of the virus in Egypt.
- Find the technological solutions necessary for dealing with the resulting risks in the case of virus outbreak.

It is worth mentioning that this competition is one of the innovation and entrepreneurship competitions which are managed under the supervision of the Academy of Scientific Research and Technology, the U.S Embassy, the Egyptian Ministry of Health and Population and the American University in Cairo. The participating students developed a Smart Coronavirus Mask “SCM” using a 3D design program. The SCM is for protection and early detection of COVID-19 and also sending the results to a mobile application that can automatically display and update the health status of the mask user. The participating students are Mark Miald, Ramzy Habel and Hassan Mohamed Hussien fourth-year students in the Medical Equipment Maintenance Department. This project was made under the supervision of Dr. Ehab Barakat, a Lecturer in the Medical Equipment Maintenance Department and Mr. Karim Saied, an Assistant Lecturer in the Department.

<https://www.pua.edu.eg/pharos-university-won-the-third-place-in-pandemic-techhack-egypt-2020-competition/>



- Cancer Prevention Month with The American Institute for Cancer Research



- Within the framework of its keenness on community service and environmental development activities, the Community Service and Environmental Development Committee of the Faculty of Applied Health Sciences Technology with all its departments participated, under the auspices of Prof. Dr. Ezzat Hassan, Dean of the Faculty, and Prof. Dr. Hamdy Al-Wakeel, Vice Dean, in raising the awareness of the University community and Faculty personnel, on Tuesday, March 1, 2022. This event tackled comprehensive cancer control, through discussing the prevention measures, encouraging early screening, diagnosis, and treatment. Furthermore, the event included distribution of fliers and posters, along with wrapped plates containing fresh fruits, cups of fresh juices to the students and Faculty personnel, who attended the event. Advocacy and outreach activities



- Raising awareness about how to combat cancer through prevention, encouraging early screening, diagnosis, and treatment.
- Encouraging the following of a diet rich in whole grains, vegetables, and fruits.
- Encourage the integration of physical activities as part of the daily life routine.

<https://www.pua.edu.eg/%d9%81%d8%b9%d8%a7%d9%84%d9%8a%d8%a9-%d8%b4%d9%87%d8%b1-%d9%85%d9%83%d8%a7%d9%81%d8%ad%d8%a9-%d8%a7%d9%84%d8%b3%d8%b1%d8%b7%d8%a7%d9%86-%d9%85%d8%b9-%d8%a7%d9%84%d9%85%d8%b9%d9%87%d8%af-%d8%a7%d9%84/>

- The Faculty of Applied Health Sciences Technology organized a campaign to raise the awareness of the faculty students about vitamin (D) deficiency on Tuesday, 10 March 2020. The campaign shed light on the importance of vitamin (D), its nutritional sources, the causes of its deficiency and deficiency tests. During the campaign, food and drinks rich with vitamin (D) were distributed. Many third-year students of the Nutrition and Food Safety Department and the fourth-year students from the







Medical Laboratory Department participated in the coordination of the day.

<https://www.pua.edu.eg/raising-awareness-of-vitamin-d-deficiency/>

- Under the auspices of Prof. Yehia Ashour, the Dean of the faculty of Dentistry, a trip was organized to the Egyptian Dental Exhibition (EDE 2020) on Thursday, 13 February 2020 in at Cairo International Convention Centre (CICC). The trip aimed at appraising the PUA delegation which included a number of faculty members, teaching assistants and students of different academic years of the state-of-the art equipment and technology in general and in the field of dentistry in particular.



<https://www.pua.edu.eg/the-faculty-of-dentistry-organized-a-trip-to-the-egyptian-dental-exhibition/>

- Community Service Committee of the Faculty of Applied Health Sciences, PUA launched “Obesity Day” initiative on Tuesday, March 22<sup>nd</sup>, 2022 in parallel with the World Obesity Day. This initiative aims to raise the awareness of the students, staff members, and faculty members, and answer their questions. It also calls representatives from the faculty members of all faculties to participate in the initiative.



<https://www.pua.edu.eg/obesity-day-initiative/>

- The Faculty of Applied Health Sciences organized a field trip for the students of the third- and fourth-year classes to El Shatby University Hospital for Children. This was held on Wednesday, 26 February 2020. During the visit, Associate Prof. Maha Youssef, the Head of the Hematology Unit escorted the delegation in a tour around the hospital different departments, including the Endocrinology Department, the Gastroenterology Department, the





Hematology Department, the Dialysis Unit and the Reception. At the end of the visit, the delegation visited the university blood bank where the students were acquainted with the blood transfusion process, the apheresis technology and the apparatus used in it.

<https://www.pua.edu.eg/a-field-trip-to-el-shatby-university-hospital-for-children/>

### 3.3.1. Vaccination activities

The Egyptian government has made COVID-19 vaccination compulsory for students above the age of 18, faculty staff and other workers at both public and private universities. Egyptian-made Chinese Sinovac shots will be supplied to vaccination centers at university hospitals to vaccinate university workers, students, and higher education staff before the beginning of the next academic year, in October. Each institute and research Centre will also establish its own vaccination clinic.

#### Vaccination activities in Pharos University

Pharos University has put a plan for vaccination against Covid 19 of students and staff members, as well as community nearby the university premises. The plan started on September 2<sup>nd</sup>, where 2500 doses of Sinovac were received associated with special 0,5 cc sterile syringes. Each dose received is enough for two persons which makes these amounts sufficient to vaccinate 5000 persons. The target number of persons to be vaccinated at the university for the local community is 14500 during the whole month of September with average daily dosages of about 232 recipients.

The vaccination work was extended till the middle of October to meet the targeted number and receiving more doses of vaccine that would be sufficient for all. Vaccinating all members of the university community would improve the chances for a return to face-to-face educational activities. However, returning to in-person education should not mean heading back to a hybrid education system. A new system “should continue on building” digital education, while adding the benefits of face-to-face activities.



<p>Waiting Hall</p>		
<p>Reporting &amp; check ups</p>		
<p>Vaccination</p>		



- The Corona Virus Boosting Dose Vaccination campaign

The Corona Virus Boosting Dose Vaccination campaign will start at the university medical clinic on Saturday the 21st of May 2022 for 10 days in the medical focal clinic. The daily timing: 9 am to 3 pm

<https://www.pua.edu.eg/the-corona-virus-boosting-dose-vaccination-campaign/>

### 3.4 Students' Community Projects in the Field of Health

- *The faculty Pharmacy and Pharmaceutical Manufacturing Project* "**Factors affecting COVID-19-related health literacy in Egyptian population**"

**Project idea:** Elevating health literacy levels of individuals can be promoted via focusing on gaining capacities, such as reading and acting upon written health information, encouraging effective communication of their needs to health professionals, and understanding health instructions (Peerson & Saunders, 2009; Schyve, 2007; Seng et al., 2020). This can be addressed by educating the public to become more resourceful via improving social responsibility about the provision of high-quality, trustworthy, easy-to-access, easy-to-understand, easy-to-use, culturally appropriate, update information about COVID-19, and relevant to various populations (Hernández-García & Giménez-Júlvez, 2020; Okan, Sørensen, et al., 2020; Paakkari & Okan, 2020). However, health literacy research of COVID-19 infodemic has remained insufficient (Paakkari & Okan, 2020), because scientists often focus on the prevention of disease, not on promoting health literacy of the disease.

- *The faculty of Allied Medical Sciences Project* "**Assessment and Intervention Program to Raise Nutritional and Health Awareness of Females in the Reproductive Age and their children in Alexandria Rural Area "Houd 10"**"

**Project Idea:** Assessment of nutrition status of rural women to tackle any nutritional problems and evaluation of their nutritional knowledge aiming at providing targeted educational sessions to raise their awareness and improve their nutritional knowledge.

- *The faculty of Dentistry Project* "**Implementing "Dental Traumatic Injuries Educational Program" Among teachers of different Governmental Elementary schools in Alexandria, Egypt.**"

**Project Idea:** Traumatic Dental Injuries (TDIs) are a serious dental public health problem among children (International Society of Preventive & Community





Dentistry, 2019). It can vary from a minor tooth fracture to extensive maxillofacial damage. Oral injuries are the fourth most common area of bodily injuries. The prevalence of Traumatic injuries in permanent teeth have been reported to exceed 60%. In Egypt, a study was conducted by ElKelany M. et al concluded that the most common areas of TDIs among children were at school (50%) then at home (30%); this was mostly due to increased predisposition of accidents, fights & sports traumas at school age.

### 3.5 Activities of Pharos University Clinics

Pharos University provides free treatment for the community in the field of dentistry and physical therapy and nutrition.

**3.5.1. The Faculty of Dentistry has six clinics:** student clinics & House Officer clinic, in addition to postgraduate clinic, outpatient clinic, dental implant clinic and operating room equipped with all modern medical equipment and equipment. These clinics provide therapeutic service annually to more than sixty thousand patients free of charge in various branches of dentistry, these services include Conservative Treatment, Filling, Fixed, Removable Prosthesis, Scaling, Root Planning, Pediatric and Minor surgery, these services done under supervision of highly qualified dental professors, these Practical Programs Prepare the Pharos Dental Student to be strong competitors in Labor Markets. <https://www.pua.edu.eg/faculty-of-dentistry/dental-clinic/>

Another special program for the final year student called CCC (Comprehensive Clinical Case) which include Complete Oral and Dental Rehabilitation of clinical case under supervision of Dental Staff. The CCC include most or all dental branches like (surgery, Periodontology, Endodontic, Restorative, Filling, Removable, Crown and Bridge). Comprehensive case care program (CCC) is one of the programs that distinguish the Faculty of Dentistry of Pharos University as graduation projects for students because they provide a community service aimed at raising health awareness through integrated treatment and diagnostic services carried out by college students completely free for a large number of patients (Table 1)



Table 1. New and follow-up Frequent Cases Visiting the Dental clinic

Academic Year	No. of Patients (CCC)	New coming cases (Free treatment)	Follow-up Frequent (cases Free treatmentCases)	Surgical cases
2019-2020	175	12882	31353	
2020-2021	75	10124	25344	
2021-2022	189	11865	40788	17
Total	439	34871	97485	17

Some examples:

BEFORE TREATMENT

AFTER TREATMENT





### 3.5.2. The Faculty of Physical Therapy external clinics include the following departments

- Clinic for orthopedics and surgery, post operational rehabilitation and sports injury.
- Clinic for disabled children suffering delayed motor skills
- Clinic for neurological disorders and its surgery
- Clinic for electromyography and nerve conduction velocities
- Clinic for women health.

<https://www.pua.edu.eg/physical-therapy/#1555829383849-6d2ec5ee-5bdf>



The outpatient clinic receive the revealed cases in orthopedics, traumatology, neurology, neurosurgery, pediatrics, delayed motor development, diabetic feet and sports injuries under supervision of faculty members in addition to



Electromyography (EMG unit). (Table 2 and Table3) shows the number of children and adult patients in the academic year 2019-2020 respectively

<https://www.pua.edu.eg/physical-therapy/facilities/physical-therapy-outpatient-clinics/>.

**Table 2.** The number of children patients in the academic year 2020 to 2022

Month	No. of Patients in pediatric clinic
January2020	50
February2020	-
March 2020	-
April 2020	-
May 2020	-
June 2020	-
July 2020	68
August2020	102
September2020	143
October2020	136
November2020	189
December2020	201
October2021	30
November2021	25
December2021	23
January2022	25
Febrauary2022	25
March2022	تم توقف العمل بعيادة الاطفال من تاريخ ( 43 3/21)
April2022	تم توقف العمل بعيادة الاطفال
May2022	تم توقف العمل بعيادة الاطفال
June2022	تم توقف العمل بعيادة الاطفال
July2022	تم توقف العمل بعيادة الاطفال
August2022	تم توقف العمل بعيادة الاطفال حتى يوم 27/8/2022
Sebtember2022	35
October2022	35



**Table 3.** The number of patients in adult clinic

Month	No. of Patients in adult clinic
January 2020	131
February 2020	-
March 2020	-
April 2020	-
May 2020	-
June 2020	-
July 2020	78
August 2020	96
September 2020	120
October 2020	143
November 2020	187
December 2020	205
October 2021	35
November 2021	39
December 2021	22
January 2022	25
February 2022	24
March 2022	23
April 2022	25
May 2022	35
June 2022	40
July 2022	49
August 2022	50
September 2022	36
October 2022	44

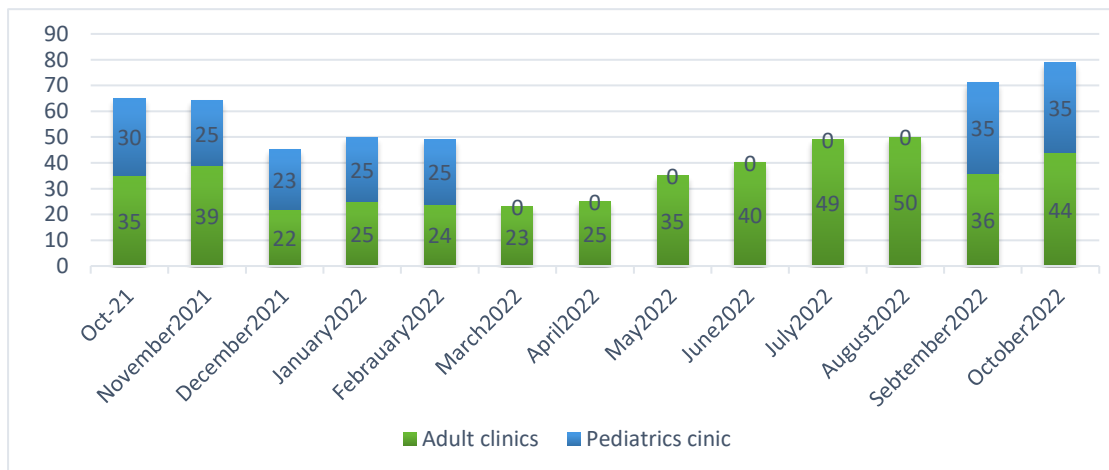



## The Physical Therapy Clinic

Several activities have been carried out in the physical therapy clinic.

1. The college held a two-day workshop on Thursday 3-3 and 17-3-2022 under the title of “sports emergency resuscitation” under the supervision of Dr. Akram Al-Daoudi, consultant orthopedic surgeon, for the fifth-year students, internship students at the college and some university graduates. The workshop yielded great results.



2. A training day was held for faculty members, the assistant staff, and the privileged staff on Monday 28/8/2022 to explain the new devices and how to operate them.





3. Part of the training activities for internship students in the outpatient clinics of the Faculty of Physiotherapy, Pharos University, on Thursday, 1/9/2022, on the applications of Electrotherapy with the latest therapeutic technologies for different therapeutic currents devices, ultrasound and therapeutic laser and how to apply them to patients in different cases to treat device diseases. The musculoskeletal and nervous system.





### 3.6 MOUS for Students Training

In 2020, the faculty of Pharmacy have signed several MOUS for cooperation between Pharos University and hospitals and pharmaceutical companies in Egypt with the aim of students training for the completion of their gradation these hospitals are:

Hospital Name with signed agreements	No of students
Alexandria University Hospital	104
Armed forced hospital	109
International center for Cardiology (ICC)	45
Andalusia Hospital	14
NAPHS	50
Zamzam Hospital - Alex	62





### 3.7 Cooperation in Health Sector

#### 3.7.1 Cooperation with Hospitals, NGOs, and Private sector

Pharos University cooperates with governmental and private national hospitals that belongs to the Ministry of Health in Alexandria and Beheria governorates (Table 4). Training of students of the faculties of Pharmacy, dentistry, Applied Health Sciences and Technology, and physical therapy are held in such hospitals.

**Table 4.** List of governmental and Private hospitals in Alexandria and Beheria Governorates that cooperated with Pharos University for t students' Training and internships

Hospital Name	Purpose
Armed Forces Hospital- Mustafa Kamel	Internships
Naval Forces Hospital	Internships
General Military Hospital	Internships
Institute of Medical research hospital	Training and internships
Faculty of Medicine Hospital of Alexandria University	Training and research
America Hospital	Training
Ahmed Maher Hospital	Students Projects
Abou Kir Hospital	Training
Gomhoria Hospital	Training
El Qasr El Ainy Hospital	Training
Dekernis Hospital	Training
Police Hospital	Training
Abou Homous Hospital	Training
Wenget Hospital	Training

Hospital Name	Purpose
El Menshawy Hospital	Training
57375 Hospital	Students activities
Burg El Arab Hospital	Students activities



### 3.7.2 Cooperation with Ministers and governmental agencies

Pharos university cooperates with ministries and national directorates in the health sector (Table 5) as well as NGO (Table 6) for implementing Students' community projects.

**Table 5.** List of Ministries and National Directorates in the health sector that Pharos University cooperated with for implementing Students' community projects.

Institute of Cultural Affairs	Students Projects
Education Directorate – Alexandria Governorate, Ministry of education	Community service projects
Education Directorate – Beheria Governorate, Ministry of education	Community service projects
Health Directorate – Ministry of Health	Community service projects
Cairo University	Research
Alexandria University	Research
Al Azhar University	Research Project
Menia University	Research Project
Academy of Science and Technology	Research Project



**Table 6.** List of NGOs that Pharos University Cooperates with for Community Service Projects

Egyptian Network for Research Ethics Committees	Research Project
Naba'a Al Hayat Foundation	Community service projects
Mojeeb Al Salayen Foundation	Community service projects
Al Staqrar Foundation	Community service projects
Kafalat Al Yateem Foundation at Fata neighborhood	Community service projects
Al Qalaa for Community Development.	Community service projects
Eleen ElGaria association	Community service projects
Abdel Kadr Association	Community service projects
Tarek Charity Association (MustafaKamel)	Community service projects
Abu Masoud Suburb (Amiria)	Community service projects
Ayadi Mostakbal medical center (NGO)	Training
Omda Development Association (NGO)	Students Projects
Association of community based rehabilitation for disabled children(NGO)	Students Projects
Red Crescent Association (Mohandeseen)	



### 3.8 Cooperation with Private sector

The private sector is an important sector that Pharos university is keen to cooperate with for different purposes, mainly for meeting, conferences, and workshops. Such meetings allow the recognition of new trends in the local and regional market and allow meeting the market needs.

**Table 7.** List of private sectors That Pharos University Cooperates with

Company name	Type of cooperation
Eva Pharma	Participation in Conference
Innova Pharma	Participation in Conference
Hygint Pharmaceutical company Ltd.	Participation in Conference
Goweily Academy	Workshops
Andalusia Hospital (Private Hospital)	Students activities
El Yousr Hospital (private Hospital)	Students Projects
Fawzy Moaaz Hospital (Private Hospital)	Students Projects
Carrefour	Partnership
Easy Care Company	Partnership
Mena For Touristic and Real Estate Development	Partnership



### International Cooperation in the field of Health:

Pharos University received a high-ranking delegation of the *KTH Royal Institute of Technology* on Thursday, 26 September 2019. The delegation was comprised of Prof. Stefan Ostlund, the Vice President for Global Relations at the KTH Royal Institute of Technology and Prof. Albania Nissan, the KTH-PUA Joint Program Leader. The visit included meetings with the aim of establishing cooperation between the two parties in the field of Pharmacy. Prof. Stefan Ostlund praised the research concerning facilities at the faculty of Pharmacy and Drug Manufacturing and gave approval to start cooperation in the field of research between the faculty and the KTH Institute. Table 8 is the list of International MOUs established with European universities in the health sector.

<https://www.pua.edu.eg/a-kth-high-ranking-delegation-in-a-visit-to-pharos-university/>

**Table 8.** List of International MOUs established with European Universities in the Health sector.

Dentistry	The University of Naples Federico II, Italy
Pharmacy	Aston University, Birmingham, UK
	Kingston University, London, UK
	The University of Naples Federico II, Italy KTH Royal Institute of Technology
	JAMK University of Applied Sciences
	School of Pharmacy, University of Eastern Finland
	AUF Agence Universitaire de la francophonie
	Kingston University
	Aston University
Physical therapy	Goethe' University , Frankfurt, Germany





### 3.9 Highlights on Research 2021

<https://www.pua.edu.eg/postgraduate-studies-and-research/research/highlights-on-research/>

Title	SDGs SciVal	Picture
<p>Epigallocatechin-3-gallate-loaded gold nanoparticles: Preparation and evaluation of anticancer efficacy in ehrlich tumor-bearing mice. Safwat, M.A.   Kandil, B.A.   Elblbesy, M.A.   Soliman, G.M.   Eleraky, N.E. Pharmaceuticals. 2020. <a href="https://doi.org/10.3390/ph13090254">https://doi.org/10.3390/ph13090254</a></p> <p>Abstract: Epigallocatechin-3-gallate (EGCG) is a pleiotropic compound with anticancer, anti-inflammatory, and antioxidant properties. To enhance EGCG anticancer efficacy, it was loaded onto gold nanoparticles (GNPs). EGCG-GNPs were prepared by a simple green synthesis method and were evaluated using different techniques. Hemocompatibility with human blood and in vivo anticancer efficacy in Ehrlich ascites carcinoma-bearing mice were evaluated. EGCG/gold chloride molar ratio had a marked effect on the formation and properties of EGCG-GNPs where well-dispersed spherical nanoparticles were obtained at a molar ratio not more than 0.8:1. The particle size ranged from ~26 to 610 nm. High drug encapsulation efficiency and loading capacity of ~93 and 32%, respectively were obtained. When stored at 4 °C for three months, EGCG-GNPs maintained over 90% of their drug payload and had small changes in their size and zeta potential. They were non-hemolytic and had no deleterious effects on partial thromboplastin time, prothrombin time, and complement protein C3 concentration. EGCG-GNPs had significantly better in vivo anticancer efficacy compared with pristine EGCG as evidenced by smaller tumor volume and weight and higher mice body weight. These results confirm that EGCG-GNPs could serve as</p>	<p>SDG 3</p>	<p>Bothaina A. Kandil Department of Radiological Science and Medical Imaging, Faculty of Allied Medical Science, Pharos University, Alexandria 21311, Egypt</p>



an efficient delivery system for EGCG with a good potential to enhance its anticancer efficacy		
--	--	--

<p>The spread of SARS-CoV-2 as an emerging novel coronavirus disease (COVID-19) had progressed as a worldwide pandemic since the end of 2019. COVID-19 affects firstly lungs tissues which are known for their very slow regeneration. Afterwards, enormous cytokine stimulation occurs in the infected cells immediately after a lung infection which necessitates good management to save patients. Exosomes are extracellular vesicles of nanometric size released by reticulocytes on maturation and are known to mediate intercellular communications. The exosomal cargo serves as biomarkers in diagnosing various diseases; moreover, exosomes could be employed as nanocarriers in drug delivery systems. Exosomes look promising to combat the current pandemic since they contribute to the immune response against several viral pathogens. Many studies have proved the potential of using exosomes either as viral elements or host systems that acquire immune-stimulatory effects and could be used as a vaccine or drug delivery tool. It is essential to stop viral replication, prevent and reverse the massive storm of cytokine that worsens the infected patients' situations for the management of COVID-19. The main benefits of exosomes could be; no cells will be introduced, no chance of mutation, lack of immunogenicity and the damaged genetic material that could negatively affect the recipient is avoided. Additionally, it was found that exosomes are static with no ability for in vivo reproduction. The current review article discusses the possibilities of using exosomes for detecting novel coronavirus and summarizes state of the art concerning the clinical trials initiated for examining the use of COVID-19 specific T cells derived exosomes</p>	SDG 3	<p>Sally A.El-Zahaby          Department of Pharmaceutics          and Pharmaceutical Technology,          Faculty of Pharmacy, Pharos          University in Alexandria,          Alexandria 21311, Egypt</p>
--	-------	--



and mesenchymal stem cells derived exosomes in managing COVID-19.		
---	--	--

<p>Niosomes of active <i>Fumaria officinalis</i> phytochemicals: Antidiabetic, antineuropathic, anti-inflammatory, and possible mechanisms of action. Raafat, K.M.   El-Zahaby, S.A. Chinese Medicine (United Kingdom). 2020  <a href="https://doi.org/10.1186/s13020-020-00321-1">https://doi.org/10.1186/s13020-020-00321-1</a></p> <p>Abstract        Background  <i>Fumaria officinalis</i> (<i>F. officinalis</i>, FO) has been used in many inflammatory and painful ailments. The main aim of this work is to perform an in-depth bio-guided phytochemical investigation of <i>F. officinalis</i> by identifying its main-active ingredients. Optimizing pharmacokinetics via niosomal-preparation will also be done to enhance their in vivo antineuropathic and anti-inflammatory potentials, and to explore their possible-mechanism of actions.</p> <p>Methods        Bio-guided phytochemical-investigations including fractionation, isolation, chromatographic-standardization, and identification of the most active compound(s) were done. Optimized niosomal formulations of <i>F. officinalis</i> most active compound(s) were prepared and characterized. An in vivo biological-evaluation was done exploring acute, subchronic, and chronic alloxan-induced diabetes and diabetic-neuropathy, and carrageenan-induced acute inflammatory-pain and chronic-inflammatory edema.</p> <p>Results</p>	<p>SDG 3</p>	<p>Sally A.El-Zahaby        Department of Pharmaceutics and Pharmaceutical Technology,        Faculty of Pharmacy, Pharos University in Alexandria,        Alexandria 21311, Egypt</p>
--	--------------	--



<p>In-vivo bio-guided fractionation and chromatographic phytochemical-analysis showed that the alkaloid-rich fraction (ARF) is the most-active fraction. ARF contained two major alkaloids; Stylophine 48.3%, and Sanguinarine 51.6%. In-vitro optimization, analytical, and in vivo biological-investigations showed that the optimized-niosome, Nio-2, was the most optimized niosomal formulation. Nio-2 had particle size <math>96.56 \pm 1.87</math> nm and worked by improving the pharmacokinetic-properties of ARF developing adequate entrapment-efficiency, rapid-degradation, and acceptable stability in simulated GI conditions. FO, ARF, and Nio 2 were the most potent antidiabetic and anti-inflammatory compounds. The reduction of the pro-inflammatory tumor necrosis factor-alpha (TNF-alpha) and Interleukin 6 (IL-6), and elevation the anti-inflammatory factor IL-10 levels and amelioration of the in vivo oxidative-stress might be the main-mechanism responsible for their antinociceptive and anti-inflammatory activities.</p> <p style="text-align: center;">Conclusions</p> <p>Fumaria officinalis most-active fraction was identified as ARF. This study offers an efficient and novel practical oral formulation ameliorating various inflammatory conditions and diabetic complications especially neuropathic-pain.</p>		
---	--	--

<p>Sitagliptin and tofacitinib ameliorate adjuvant induced arthritis via modulating the cross talk between JAK/STAT and TLR-4/NF-κB signaling pathways. Ibrahim, S.S.A.   Salama, M.A.   Selima, E.   Shehata, R.R. Life Sciences. 2020 <a href="https://doi.org/10.1016/j.lfs.2020.118261">https://doi.org/10.1016/j.lfs.2020.118261</a></p> <p style="text-align: center;"><u>Abstract</u> Aims</p>	SDG 3	 <p style="text-align: center;">Sherihan Salaheldin Abdelhamid Ibrahim</p>
---	-------	---



<p>Rheumatoid arthritis is an autoimmune systemic disorder causing pain, swelling, stiffness, and disability in various joints. This work was designed to evaluate the effect of sitagliptin and tofacitinib on Janus kinase (JAK)/signaling transducer and activator of transcription (STAT) and toll like receptor (TLR-4)/nuclear factor kappa B (NF-κB) signaling pathways in adjuvant induced arthritis in rats.</p> <p>Materials and methods Severity of arthritis was evaluated and serum was analyzed for inflammatory mediators. The mRNA and protein expression level of the most important members of the two signaling pathways were determined. Lipid profile, transaminases and renal function parameters were assessed.</p> <p>Key findings Sitagliptin and tofacitinib significantly decreased the level of inflammatory parameters, the mRNA and protein expression level of the members of JAK/STAT and TLR-4/NF-κB pathways with more prominent effect of sitagliptin on TLR-4/NF-κB pathway and more expected obvious effect of tofacitinib on JAK/STAT pathway. The combination offered additional anti-inflammatory effect by inhibiting the cross talk between these pathways as inhibition of NF-κB activation decreased the serum level of IL-6 preventing the activation of STAT-3 in tibiotarsal tissues.</p> <p>Significance The combination of tofacitinib and sitagliptin normalized serum lipids and blood glucose level which could offer protection against cardiovascular diseases and caused partial reversal of serum transaminases and creatinine levels which can protect against tofacitinib's related hepato and nephrotoxicity. We could conclude that the</p>		<p>Department of Pharmacology and Therapeutics, Pharos University in Alexandria, Alexandria, Egypt</p>
---	--	--





combination of Sitagliptin with tofacitinib can offer synergistic anti-inflammatory effect and more protective action against side effects of tofacitinib.		
--	--	--

<p>Effective cellular transport of ortho-halogenated sulfonamide derivatives of metformin is related to improved antiproliferative activity and apoptosis induction in MCF-7 cells. Markowicz-Piasecka, M.   Komeil, I.   Huttunen, J.   Sikora, J.   Huttunen, K.M. International Journal of Molecular Sciences. 2020 <a href="https://doi.org/10.3390/ijms21072389">https://doi.org/10.3390/ijms21072389</a></p> <p><u>Abstract</u></p> <p>Metformin is a substrate for plasma membrane monoamine transporters (PMAT) and organic cation transporters (OCTs); therefore, the expression of these transporters and interactions between them may affect the uptake of metformin into tumor cells and its anticancer efficacy. The aim of this study was to evaluate how chemical modification of metformin scaffold into benzene sulfonamides with halogen substituents (compounds 1–9) may affect affinity towards OCTs, cellular uptake in two breast cancer cell lines (MCF-7 and MDA-MB-231) and antiproliferative efficacy of metformin. The uptake of most sulfonamides was more efficient in MCF-7 cells than in MDA-MB-231 cells. The presence of a chlorine atom in the aromatic ring contributed to the highest uptake in MCF-7 cells. For instance, the uptake of compound 1 with o-chloro substituent in MCF-7 cells was <math>1.79 \pm 0.79</math> nmol/min/mg protein, while in MDA-MB-231 cells, the uptake was considerably lower (<math>0.005 \pm 0.0005</math> nmol/min/mg protein). The elevated uptake of tested compounds in MCF-7 was</p>	SDG 3	 <p>Ibrahim Komeil Department of Pharmaceutics, Faculty of Pharmacy and Drug Manufacturing, Pharos University, Alexandria 21311, Egypt</p>
--	-------	---



<p>accompanied by high antiproliferative activity, with compound 1 being the most active (IC<sub>50</sub> = 12.6 ± 1.2 μmol/L). Further studies showed that inhibition of MCF-7 growth is associated with the induction of early and late apoptosis and cell cycle arrest at the G<sub>0</sub>/G<sub>1</sub> phase. In summary, the chemical modification of the biguanide backbone into halogenated sulfonamides leads to improved transporter-mediated cellular uptake in MCF-7 and contributes to the greater antiproliferative potency of studied compounds through apoptosis induction and cell cycle arrest.</p>		
--	--	--

<p>Lactoferrin/Hyaluronic acid double-coated lignosulfonate nanoparticles of quinacrine as a controlled release biodegradable nanomedicine targeting pancreatic cancer. Etman, S.M.   Abdallah, O.Y.   Mehanna, R.A.   Elnaggar, Y.S.R. International Journal of Pharmaceutics. 2020 <a href="https://doi.org/10.1016/j.ijpharm.2020.119097">https://doi.org/10.1016/j.ijpharm.2020.119097</a></p> <p><u>Abstract</u></p> <p>Quinacrine is an antimalarial drug that was repositioned for treatment of cancer. This is the first work to enhance quinacrine activity and minimize its associated hepatotoxicity via loading into biodegradable, bio-renewable lignosulfonate nanoparticles. Particles were appraised for treatment of pancreatic cancer, one of the most life-threatening tumors with a five-year survival estimate. Optimum nanocomposites prepared by polyelectrolyte interaction exhibited a particle size of 138 nm, a negative surface charge (-28 mV) and a pH dependent release of the drug in an acidic environment. Ligands used for active targeting (lactoferrin and hyaluronic acid) were added to nanoparticles' surface via layer by layer coating technique. The highest anticancer activity on PANC-1 cells was demonstrated with dual active targeted particles (3-fold decrease in IC<sub>50</sub>) along with an increased ability to inhibit migration and invasion of pancreatic cancer cells. In vivo studies revealed that</p>	<p>SDG 3</p>	 <p>Yosra S.R.Elnaggar Head of International Publication and Nanotechnology Center INCC, Department of Pharmaceutics, Faculty of Pharmacy and Drug Manufacturing, Pharos University of Alexandria, Egypt</p>
---	--------------	---



<p>elaborated nanoparticles particles showed the highest tumor volume reduction with enhanced survival without any toxicity on major organs. In conclusion, the elaborated nanoparticles could be considered as a promising targeted nanotherapy for treatment of pancreatic cancer with higher efficacy&amp; survival rate and lower organ toxicity.</p>		
---	--	--

<p>In vivo bio-distribution and acute toxicity evaluation of greenly synthesized ultra-small gold nanoparticles with different biological activities. Aljohani, F.S.   Hamed, M.T.   Bakr, B.A.   Shahin, Y.H.   Abu-Serie, M.M.   Awaad, A.K.   El-Kady, H.   Elwakil, B.H. Scientific Reports. 2022 <a href="https://doi.org/10.1038/s41598-022-10251-7">https://doi.org/10.1038/s41598-022-10251-7</a></p> <p>Abstract</p> <p>Ultra-small gold nanoparticles (Au-NPs) “≤10 nm diameters” have potent biomedical applications. Hence, the present study aimed to greenly synthesize ultra-small gold nanoparticles using Egyptian propolis extract. Different biological activities, in vivo bio-distribution and acute toxicity study were assessed. Results revealed that, Egyptian propolis extract can successfully synthesize the highly pure and stable ultra-small Au-NPs with average diameter 7.8 nm. In vitro antimicrobial and antimycobacterial activities revealed the powerful effect of the prepared Au-NPs. Moreover, the cytotoxic effect on human cancer cell lines revealed the potent inhibition of the cancer cells’ proliferation with high reactive oxygen species-mediated apoptosis induction. In vivo bio-distribution and acute toxicity studies were performed (10 and 100 mg/kg doses) in male albino rats. The ultra-small Au-NPs showed low or no toxicity upon using the Au-NPs low dose. The mean area accumulation (%) of the Au-NPs was higher in the liver, kidney, and brain tissues (4.41, 2.96, and 0.3 times, respectively) treated with high Au-NPs</p>	<p>SDG 3</p>	 <p>Bassma Elwakil Department of Medical Laboratory Technology, Faculty of Applied Health Sciences Technology, Pharos University in Alexandria, Alexandria, Egypt</p>
--	--------------	--



<p>dosage compared to those treated with the low dose. Surprisingly, Au-NP accumulation in brain tissue was observed in the glial cells only. Accordingly, the low dose (10 mg/kg) of Au-NPs can be used safely in a variety of biomedical applications.</p>		
--	--	--

<p>Novel Hybrid 1,2,4-and 1,2,3-Triazoles Targeting Mycobacterium Tuberculosis Enoyl Acyl Carrier Protein Reductase (InhA): Design, Synthesis, and Molecular Docking. El Sawy, M.A.   Elshatanofy, M.M.   El Kilany, Y.   Kandeel, K.   Elwakil, B.H.   Hagar, M.   Aouad, M.R.   Albelwi, F.F.   Rezki, N.   Jaremko, M.   El Ashry, E.S.H.</p> <p>International Journal of Molecular Sciences. 2022 <a href="https://doi.org/10.3390/ijms23094706">https://doi.org/10.3390/ijms23094706</a></p> <p><b>Abstract</b></p> <p>Tuberculosis (TB) caused by Mycobacterium tuberculosis is still a serious public health concern around the world. More treatment strategies or more specific molecular targets have been sought by researchers. One of the most important targets is M. tuberculosis' enoyl-acyl carrier protein reductase InhA which is considered a promising, well-studied target for anti-tuberculosis medication development. Our team has made it a goal to find new lead structures that could be useful in the creation of new antitubercular drugs. In this study, a new class of 1,2,3- and 1,2,4-triazole hybrid compounds was prepared. Click synthesis was used to afford 1,2,3-triazoles scaffold linked to 1,2,4-triazole by fixable mercaptomethylene linker. The new prepared compounds have been characterized by different spectroscopic tools. The designed compounds were tested in vitro against the InhA enzyme. At 10 nM, the inhibitors 5b, 5c, 7c, 7d, 7e, and 7f successfully and totally (100%) inhibited the</p>	<p>SDG 3</p>	<p>Maged A. El Sawy Department of Pharmaceutical Chemistry, Faculty of Pharmacy, Pharos University, Alexandria 21311, Egypt</p>  <p>Bassma Elwakil Department of Medical Laboratory Technology, Faculty of Applied Health Sciences Technology, Pharos University in Alexandria, Alexandria, Egypt</p>
---	--------------	--



<p>InhA enzyme. The IC50 values were calculated using different concentrations. With IC50 values of 0.074 and 0.13 nM, 7c and 7e were the most promising InhA inhibitors. Furthermore, a molecular docking investigation was carried out to support antitubercular activity as well as to analyze the binding manner of the screened compounds with the target InhA enzyme's binding site</p>		
---	--	--

<p>Anti-neoplastic action of Cimetidine/Vitamin C on histamine and the PI3K/AKT/mTOR pathway in Ehrlich breast cancer. Ibrahim, S.S.A.   El-Aal, S.A.A.   Reda, A.M.   Achy, S.E.   Shahine, Y. Scientific Reports. 2022 <a href="https://doi.org/10.1038/s41598-022-15551-6">https://doi.org/10.1038/s41598-022-15551-6</a></p> <p><u>Abstract</u></p> <p>The main focus of our study is to assess the anti-cancer activity of cimetidine and vitamin C via combating the tumor supportive role of mast cell mediators (histamine, VEGF, and TNF-<math>\alpha</math>) within the tumor microenvironment and their effect on the protein kinase A(PKA)/insulin receptor substrate-1(IRS-1)/phosphatidylinositol-3-kinase (PI3K)/serine/threonine kinase-1 (AKT)/mammalian target of rapamycin (mTOR) cue in Ehrlich induced breast cancer in mice. In vitro study was carried out to evaluate the anti-proliferative activity and combination index (CI) of the combined drugs. Moreover, the Ehrlich model was induced in mice via subcutaneous injection of Ehrlich ascites carcinoma cells (EAC) in the mammary fat pad, and then they were left for 9 days to develop obvious solid breast tumor. The combination therapy possessed the best anti-proliferative effect, and a CI&lt;1 in the MCF7 cell line indicates a synergistic type of drug interaction. Regarding the in vivo study, the combination abated the elevation in the tumor volume, and serum tumor marker carcinoembryonic antigen (CEA) level. The serum vascular endothelial growth factor (VEGF) level and immunohistochemical staining for CD34 as markers of angiogenesis were mitigated.</p>	<p>SDG 3</p>	<div data-bbox="1098 797 1318 1097" data-label="Image"></div> <p>Sherihan Salaheldin Abdelhamid Ibrahim Department of Pharmacology and Therapeutics, Faculty of Pharmacy, Pharos University in Alexandria, Alexandria, Egypt</p> <div data-bbox="1098 1447 1318 1702" data-label="Image"></div> <p>Yasmine Shahine Department of Microbiology &amp; Immunology, Faculty of Pharmacy, Pharos University in Alexandria, Alexandria, Egypt</p>
--	--------------	---





<p>Additionally, it reverted the state of oxidative stress and inflammation. Meanwhile, it caused an increment in apoptosis, which prevents tumor survival. Furthermore, it tackled the elevated histamine and cyclic adenosine monophosphate (cAMP) levels, preventing the activation of the (PKA/IRS-1/PI3K/AKT/mTOR) cue. Finally, we concluded that the synergistic combination provided a promising anti-neoplastic effect via reducing the angiogenesis, oxidative stress, increasing apoptosis, as well as inhibiting the activation of PI3K/AKT/mTOR cue, and suggesting its use as a treatment option for breast cancer.</p>		
---	--	--

<p>Luteolin mediated targeting of protein network and microRNAs in different cancers: Focus on JAK-STAT, NOTCH, mTOR and TRAIL-mediated signaling pathways. Farooqi, A.A.   Butt, G.   El-Zahaby, S.A.   Attar, R.   Uteuliyev, Y.S   Jovic, J.J.   Tang, K.-F.   Naureen, H.   Xu, B. Pharmacological Research. 2020 <a href="https://doi.org/10.1016/j.phrs.2020.105188">https://doi.org/10.1016/j.phrs.2020.105188</a></p> <p><u>Abstract</u></p> <p>There has always been a keen interest of basic and clinical researchers to search for cancer therapeutics having minimum off-target effects and maximum anticancer activities. In accordance with this approach, there has been an explosion in the field of natural products research in the past few decades because of extra-ordinary list of natural extracts and their biologically and pharmacologically active constituents having significant medicinal properties. Apparently, luteolin-mediated anticancer effects have been investigated in different cancers but there is superfluosness of superficial data. Generalized scientific evidence encompassing apoptosis, DNA damage and anti-inflammatory effects has been reported extensively. However, how luteolin modulates deregulated oncogenic pathways in different cancers has not been comprehensively uncovered. In this review we have attempted to</p>	<p>SDG 3</p>	<p>Sally A.El-Zahaby Department of Pharmaceutics and Pharmaceutical Technology, Faculty of Pharmacy, Pharos University in Alexandria, Alexandria 21311, Egypt</p>
---	--------------	---



<p>focus on cutting-edge research which has unveiled remarkable abilities of luteolin to modulate deregulated oncogenic pathways in different cancers. We have partitioned the review into various sections to separately discuss advancements in therapeutic targeting of oncogenic protein networks. We have provided detailed mechanistic insights related to JAK-STAT signaling and summarized how luteolin inhibited STAT proteins to inhibit STAT-driven gene network. We have also individually analyzed Wnt/<math>\beta</math>-catenin and NOTCH pathway and how luteolin effectively targeted these pathways. Mapping of the signaling landscape has revealed that NOTCH pathway can be targeted therapeutically. NOTCH pathway was noted to be targeted by luteolin. We have also conceptually analyzed how luteolin restored TRAIL-induced apoptosis in resistant cancers. Luteolin induced an increase in pro-apoptotic proteins and efficiently inhibited anti-apoptotic proteins to induce apoptosis. Luteolin mediated regulation of non-coding RNAs is an exciting and emerging facet. Excitingly, there is sequential and systematic accumulation of clues which have started to shed light on intricate regulation of microRNAs by luteolin in different cancers. Collectively, sophisticated information will enable us to develop a refined understanding of the multi-layered regulation of signaling pathways and non-coding RNAs by luteolin in different cancers.</p>		
---	--	--

<p>Valsartan solid lipid nanoparticles integrated hydrogel: A challenging repurposed use in the treatment of diabetic foot ulcer, in-vitro/in-vivo experimental study. El-Salamouni, N.S.   Gowayed, M.A.   Seiffein, N.L.   Abdel- Moneim, R.A.   Kamel, M.A.   Labib, G.S. International Journal of Pharmaceutics. 2021  <a href="https://doi.org/10.1016/j.ijpharm.2020.120091">https://doi.org/10.1016/j.ijpharm.2020.120091</a>  <a href="#">Abstract</a></p>	<p>SDG 3</p>	 <p>Noha S. El-Salamouni        Department of Pharmaceutics &amp;</p>
--	--------------	--



<p>The article presents an experimental study on the possible repurposed use of valsartan (Val), in the local treatment of uncontrolled diabetic foot ulcer. Solid lipid nanoparticles (SLN), loaded with Val were prepared by applying 32 full factorial design using modified high shear homogenization method. The lipid phase composed of Precirol® ATO 5 (P ATO 5) and/or Gelucire 50/13 (G 50/13) in different ratios and a nonionic emulsifier, Pluronic 188 (P188), was used in different percentages. Optimized formulation was further integrated in hydroxyl propyl methyl cellulose (HPMC) gel for the ease of administration.</p> <p>In-vitro and in-vivo characterizations were investigated. The prepared nanoparticles showed small particle size, high entrapment efficiency and sustained drug release. Microbiologically, Val-SLN showed a prominent decrease in the biofilm mass formation for both gram-positive and gram-negative bacteria, as well as a comparable minimum inhibitory concentration level to levofloxacin alone.</p> <p>Diabetes was induced in 32 neonatal Sprague-Dawley rats. At 8 weeks of age, rats with blood sugar level &gt;160 were subjected to surgically induced ulcer. Treatment with Val-SLN for 12 days revealed enhanced healing characteristics through cyclooxygenase-2 (COX-2), nuclear factor kappa-light-chain-enhancer of activated B cells (NF-κB), nitric oxide (NO), transforming growth factor-beta (TGF-β), matrix metalloproteinase (MMPs) and vascular endothelial growth factor (VEGF) pathways. Histological examination revealed re-epithelization in Val-SLN treated ulcer, as well as decrease in collagen using trichrome histomorphometric analysis.</p>		<p>Pharmaceutical Technology, Faculty of Pharmacy, Pharos University in Alexandria, Alexandria, Egypt</p>  <p>Mennatallah A. Gowayed Department of Pharmacology &amp; Therapeutics, Faculty of Pharmacy, Pharos University in Alexandria, Alexandria, Egypt</p> <p>Nevine L. Seiffein Department of Microbiology &amp; Immunology, Faculty of Pharmacy, Pharos University in Alexandria, Alexandria, Egypt</p>
---	--	---

<p>Oral genistein-loaded phytosomes with enhanced hepatic uptake, residence and improved therapeutic efficacy against hepatocellular carcinoma. Komeil, I.A.   El-Refaie, W.M.   Gowayed, M.A.   El-Ganainy, S.O.   El Achy, S.N.   Huttunen, K.M.   Abdallah, O.Y. International Journal of Pharmaceutics. 2021 <a href="https://doi.org/10.1016/j.ijpharm.2021.120564">https://doi.org/10.1016/j.ijpharm.2021.120564</a></p> <p>Abstract</p>	<p>SDG 3</p>	 <p>Ibrahim Komeil</p>
--	--------------	---



[Genistein](#) (Gen) is one of the most potent soy [isoflavones](#) used for [hepatocellular carcinoma](#) (HCC) treatment. Low aqueous solubility and first-pass metabolism are the main obstacles resulting in low Gen oral bioavailability. The current study aims to introduce [phytosomes](#) as an approach to improve Gen solubility, protect it from metabolism by complexation with [phospholipids](#) (PL), and get used to PL in Gen lymphatic delivery. Different forms of PL namely: Lipiod® S100, Phosal® 53 [MCT](#), and Phosal®75 SA were used in phytosomes preparation GP, GPM, and GPL respectively. The effect of formulation components on Gen absorption, metabolism, and liver accumulation was evaluated following oral administration to rats. Cytotoxicity and cellular uptake studies were applied on HepG2 cells and *in-vivo* anti-tumor studies were applied to the DEN-mice model. Results revealed that GP and GPL remarkably accumulated Gen [aglycone](#) in hepatic cells and minimized the metabolic effect on Gen.

They significantly increased the intracellular accumulation of Gen in its complex form in HepG2 cells. Their cytotoxicity is time-dependent according to the complex stability. The enhanced *in-vivo* anti-tumor effect was observed for GP and GPL compared to Gen suspension on DEN-induced HCC in mice. In conclusion, Gen-phytosomes can represent a promising approach for liver cancer treatment.



Wessam M.El-Refai  
Department of  
Pharmaceutics, Faculty of  
Pharmacy and Drug  
Manufacturing, Pharos  
University, Alexandria  
21311, Egypt



Mennatallah A. Gowayed



Samar O.El-Gainy  
Department of  
Pharmacology &  
Therapeutics, Faculty of  
Pharmacy, Pharos  
University in Alexandria,  
Alexandria, Egypt



Pegylated liquisomes: A novel combined passive targeting nanoplatform of L-carnosine for breast cancer. Gaafar, P.M.E. | El-Salamouni, N.S. | Farid, R.M. | Hazzah, H.A. | Helmy, M.W. | Abdallah, O.Y. International Journal of Pharmaceutics. 2021 <https://doi.org/10.1016/j.ijpharm.2021.120666>

Abstract

PEGylated Liquisomes (P-Liquisomes), a novel drug delivery system was designed for the first time by incorporating phospholipid complex in PEGylated liquid crystalline nanoparticles (P-LCNPs). L-carnosine (CN), a challenging dipeptide, has proven to be a promising anti-cancer drug. However, it exhibits high water solubility and extensive *in-vivo* degradation that halts its use. The objective of this work was to investigate the ability of our novel system to improve the CN anticancer activity by prolonging its release and protecting it *in-vivo*. *In-vitro* appraisal revealed spherical light-colored vesicles encapsulated in the liquid crystals, confirming the successful formation of the combined system. P-Liquisomes were nano-sized ( $149.3 \pm 1.4$  nm), with high ZP ( $-40.2 \pm 1.5$  mV), complexation efficiency ( $97.5 \pm 0.9\%$ ) and outstanding sustained release of only 75.4% released after 24 h, compared to P-LCNPs and Phytosomes. The results obtained with P-Liquisomes are considered as a break through compared to P-LCNPs or Phytosomes alone, especially when dealing with the hydrophilic CN. *In-vitro* cytotoxicity evaluation, revealed superior cytotoxic effect of P-Liquisomes ( $IC_{50} = 25.9$ ) after 24 h incubation. Besides, P-Liquisomes proved to be non-toxic *in-vivo* and succeeded to show superior chemopreventive activity manifested by reduction of; % tumor growth (7.1%), VEGF levels (14.3 pg/g tissue), cyclin D1 levels 15.5 ng/g tissue and elevation in caspase-3 level (36.4 ng/g tissue), compared to Phytosomes and CN solution. Conclusively, P-Liquisomes succeeded to achieve the maximum therapeutic outcome of CN without altering its activity and might be used as a sustained delivery system for other promising hydrophilic compounds.

SDG 3



Ragwa M. Farid  
Department of  
Pharmaceutics &  
Pharmaceutical  
Technology, Faculty of  
Pharmacy, Pharos  
University in Alexandria,  
Alexandria, Egypt





Pectin coated nanostructured lipid carriers for targeted piperine delivery to hepatocellular carcinoma. Shehata, E.M.M. | Gowayed, M.A. | El-Ganainy, S.O. | Sheta, E. | Elnaggar, Y.S.R. | Abdallah, O.Y. International Journal of Pharmaceutics. 2022 <https://doi.org/10.1016/j.ijpharm.2022.121712>

#### Abstract

Piperine (PIP) is a herbal drug with well-known anticancer activity against different types of cancer including hepatocellular carcinoma. However, low aqueous solubility and extensive first-pass metabolism limit its clinical use. In this study, positively charged PIP-loaded nanostructured lipid carriers (PIP-NLCs) were prepared via melt-emulsification and ultrasonication method followed by pectin coating to get novel pectin-coated NLCs (PIP-P-NLCs) targeting hepatocellular carcinoma. Complete in vitro characterization was performed. In addition, cytotoxicity and cellular uptake of nanosystems in HepG2 cells were evaluated. Finally, in vivo anticancer activity was tested in the diethylnitrosamine-induced hepatocellular carcinoma mice model. Successful pectin coating was confirmed by an increased particle size of PIP-NLCs from  $150.28 \pm 2.51$  nm to  $205.24 \pm 5.13$  nm and reversed Zeta potential from  $33.34 \pm 3.52$  mV to  $-27.63 \pm 2.05$  mV. Nanosystems had high entrapment efficiency, good stability, spherical shape, and sustained drug release over 24 h. Targeted P-NLCs enhanced the cytotoxicity and cellular uptake compared to untargeted NLCs. Furthermore, PIP-P-NLCs improved in vivo anticancer effect of PIP as proved by histological examination of liver tissues, suppression of liver enzymes and oxidative stress environment in the liver, and alteration of cell cycle regulators. To conclude, PIP-P-NLCs can act as a promising approach for targeted delivery of PIP to hepatocellular carcinoma.

SDG 3



Yosra S.R. Elnaggar  
Head of International  
Publication and  
Nanotechnology Center  
INCC, Department of  
Pharmaceutics, Faculty  
of Pharmacy and Drug  
Manufacturing, Pharos  
University of Alexandria,  
Egypt



Mennatallah A. Gowayed



Samar O. El-Ganainy  
Department of  
Pharmacology &  
Therapeutics, Faculty of  
Pharmacy, Pharos  
University in Alexandria,  
Alexandria, Egypt



<p>Egyptian <i>Olea europaea</i> leaves bioactive extract: Antibacterial and wound healing activity in normal and diabetic rats. Elnahas, R.A.   Elwakil, B.H.   Elshewemi, S.S.   Olama, Z.A. Journal of Traditional and Complementary Medicine. 2021  <a href="https://doi.org/10.1016/j.jtcme.2021.02.008">https://doi.org/10.1016/j.jtcme.2021.02.008</a></p> <p style="text-align: center;">Abstract</p> <p style="text-align: center;">Background and aim</p> <p>In vitro activity evaluation of Egyptian <i>Olea europaea</i> leaves extracts, and in vivo healing activity assessment of the newly prepared ointment of <i>Olea europaea</i> leaves extracts mingled with Shea butter.</p> <p style="text-align: center;">Experimental procedure</p> <p>Different extraction methods and solvents were used to extract Egyptian <i>Olea europaea</i> bioactive agent(s). Antibacterial, scavenging activity and in-vivo evaluation of wound repair potentiality of <i>Olea europaea</i> extract were examined in normal and diabetic experimental rat models with induced circular excisions.</p> <p style="text-align: center;">Results and conclusion</p> <p>Olive leaves extract of Tanta was selected as the most active agent against Methicillin-resistant <i>S. aureus</i> (MRSA), with MIC value 15.6 µg/ml. Moreover, checkerboard dilution technique approved that the interaction between Tanta LEM crude extract and Ciprofloxacin was synergistic. Scavenging activity of the extract against DPPH free radicals was 87.55% at concentration of 50 µg/ml. In vivo normal and diabetic experimental rats treated with Shea butter: Tanta LEM extract (1:3 w/v) showed the maximum wound contraction and healing activity.</p>	<p>SDG 3</p>	 <p>Bassma Elwakil        Department of Medical Laboratory Technology,        Faculty of Applied Health Sciences Technology,        Pharos University in Alexandria, Alexandria,        Egypt</p>
---	--------------	--



### 3.10 Courses in Curricula

No	Faculty in Pharos University	Course name	Course code	SDG of relevance	Topics in each course
1	Applied Health Sciences Technology	Psychology	MGSY-201	SDG 3	Mental well being
2	Applied Health Sciences Technology	Infection Control	MLIC-401	SDG 3	Hygiene for good health
3	Applied Health Sciences Technology	Ethical and Legal Issues in Health Fields	MGME-101	SDG 3	Wellbeing and living standards
4	Pharmacy	Medicinal Chemistry I	(PCD 301) and (PCC 401)	SDG 3	Diagnostic agents that treat different infections
5	Pharmacy	Public Health and Preventive Medicine	PMC 401	SDG 3	Society health and wellbeing
6	Pharmacy	Project in Pharmacognosy & Natural Products	PG E08	SDG 3	Sustainable use of natural resources
7	Pharmacy	Nutrition & Health	PL 416	SDG 3	Combating malnutrition, Society health and wellbeing
8	Pharmacy	Public Health	PM 305	SDG 3	Society health and wellbeing



No	Faculty in Pharos University	Course name	Course code	SDG of relevance	Topics in each course
9	Pharmacy	Home Health Care	PN E19	SDG 3	Wellbeing of women health at home to reduce inequalities
10	Pharmacy	First Aid and Basic Life Support (BLS)	PLC 303	SDG 3	Society health and wellbeing
11	Pharmacy	Natural Cosmetics	PGD E01	SDG 3	Sustainable use of natural resources
12	Pharmacy	Herbal medicine	PGD E02	SDG 3	Sustainable use of natural resources
13	Pharmacy	Sustainability in Therapeutics	PLD E03	SDG 3	Sustainable use of natural resources
14	Pharmacy	Medicinal Chemistry II	(PCD 302) and (PCC 403)	SDG 3	pharmacological aspects of medicinal and pharmaceutical agents that belong to different categories
15	Pharmacy	Drug Design	(PCD 401) and (PCC E02)	SDG 3	Essentials of pharmaceutical chemistry and metabolism. Development of prodrugs, soft drugs, hard drugs



No	Faculty in Pharos University	Course name	Course code	SDG of relevance	Topics in each course
16	Pharmacy	Analysis of food & flavors	(PCD E02) and (PCC E03)	SDG 3	classification of flavoring agents and chemesthetic compounds found in food, their chemistry and methods of analysis.
17	Artificial Intelligence	Bioinformatics Programming and Scripting	DS307	SDG 3	Medical data handing
18	Artificial Intelligence	Biomedical Imaging	DS407	SDG 3	Medical data handing
19	Tourism	Current issues in food service (Elective)	HM 336	SDG 3	Healthy food for wellbeing, consumption reduction
20	Tourism	Safe Food Service Management	HM 434	SDG 3	Healthy food for wellbeing, consumption reduction
21	Dentistry	Dental clinic management & infection control	CD 312	SDG 3	Human health protection and control of infection in dental clinics
22	Physical Therapy	Public Health	PTBA 216	SDG 3	Good health of society particularly for poor
23	Physical Therapy	Psychology of Handicapped	PTBA 217	SDG 3	Psychic problem and treatment
24	Physical Therapy	Clinical Psychology	PTBA 337	SDG 3	Treatment sessions of Psychic patients
25	Physical Therapy	Woman Health Physical Therapy	PTWH 446	SDG 3	Women health and treatment



## SDG 4 – Quality Education

A high-quality education should be an area where universities excel. Education is a key gateway to inequalities, especially multigenerational ones. In addition to improving quality of life, access to inclusive education can help equip locals with the tools required to develop innovative solutions to the world's greatest problems. SDG 4 explores early years and lifelong learning. We are exploring how universities support early years, lifelong learning, and their nations through ensuring equality of access to their facilities.

## Quality Education Events

### [Workshops at Pharos University in collaboration with KTH](#)

Within the framework of the cooperation with the Royal Institute of Technology in Sweden, Pharos University in Alexandria received a group of professors from the Royal Institute of Technology in Sweden (KTH) from the 13th to 16th of June 2022 to hold the workshops held at the university, where Assoc. Prof Albania Nissan in partnership with Prof. Anita Kullen presented a workshop entitled Workshop on Degree Project, where this workshop dealt with how to plan and follow up on students' projects of the Faculty of Engineering and the method followed by KTH in this regard. In addition to that, Dr. Elena Malakhotka presented a workshop entitled VR Solution Applied in Educational Programs and these workshops were attended by a group of faculty members and the staff to keep pace with the development in the educational process.



URL: [Workshops at Pharos University in collaboration with KTH | Pharos University in Alexandria \(pua.edu.eg\)](#)





## [Field Visit to the Alexandria Petroleum Company](#)

The Mechanical Engineering Department organized a field visit to the Alexandria Petroleum Company for 40 of its students from different academic levels for one full day. The students were accompanied with several Department professors.

At the beginning, the company lectured the students about the company's activities, stages of separating petroleum and distilling it into its various constituents. As well as the mechanical devices and equipment used to raise pressure, heating, evaporation, and distillation towers.

After that, engineers from the company took the students on a field tour to see what was demonstrated on the ground. It is worth noting that the company's training and human development officials commended the students' passion and interest in the practical side. As well as their good behavior and commitment during the visit.



URL: [Field Visit to the Alexandria Petroleum Company | Pharos University in Alexandria \(pua.edu.eg\)](#)



## [PUA and IdeaSpace Sign a Cooperation Protocol](#)

In implementation of its field training plan, PUA signed a cooperation protocol with IdeaSpace Company, which represents the “Egypt Makes Electronics” initiative (EME) of the Information the Information Technology Industry Development Agency (ITIDA) to train PUA’s students.

This event was attended by:

**Dr. Ramadan Abu El-Ala**

Vice President for Community Service and Environment Development Affairs.

**Ahmed Mohamed Hassan**

CEO of IdeaSpace and EME Project Manager in Alexandria and Assiut.

**Prof. Dr. Mohamed Ismail Badawy**

Head of Department of Biomedical Equipment Technology.

**Eng. Abdullah Assem,**

Director of Training Programs.



URL: [PUA and IdeaSpace Sign a Cooperation Protocol | Pharos University in Alexandria](#)



## Education Development

In recognition of the Faculty Applied Health Sciences Technology and the Department of Biomedical Equipment Technology of the necessity of developing education through linking the academic activities with the Egyptian industrial initiatives; In pursuance of PUA's Administration's directives, and under the auspices of Prof. Dr. Ezzat Hassan, Dean of the Faculty and Prof. Dr. Hamdy Al-Wakil, Vice Dean for Education and Student Affairs; Based on coordination made by Asst. Prof. Dr. Mohamed Ismail Badawy, Head of the Department of Biomedical Devices Technology; *and* In response to the invitation extended by "Egypt Make Electronics" initiative (EME), which is funded by the Information Technology Industry Development Agency (ITEDA), of the Ministry of Communications, 17 Department students along with five faculty members and teaching assistants visited EME's Innovation Hub-Borg Al Arab.



The visit aimed to identify the possibilities available, and to open horizons for the Department students to implement their graduation projects.

As a result, the students learned about the initiative's capabilities and its advanced laboratories, such as printed circuit laboratories, manufacturing laboratories, artificial intelligence laboratories, and Internet of Things laboratories

URL: [Education Development | Pharos University in Alexandria \(pua.edu.eg\)](https://pua.edu.eg)





### [Graduation Projects Judging In Techno-Hayat Magazine](#)

PUA's Faculty of Mass Communication initiated the discussion and arbitration of the

graduation projects of the fourth-year journalism and digital publishing students of the "Techno-Hayat" project. The students discussed their



graduation

project "Techno-Hayat", which is a magazine and website specialized in various fields of technology. The professors also gave a number of advices to the students about the media job market, how to excel, and the elements of a successful journalist amidst the digital transformation.

Further, this magazine aims to develop societal awareness of technological development, shed light on the positive side of technology, and provide solutions to its negative aspects. In addition, it shows how technology can be utilized in increasing productivity through the "Services – Technologies – Health, Culture and Art" tabs. It is also worth noting that the Techno-Hayat project has been generated by the faculty's laboratories as part of the "Make Your Own Project" initiative, which was launched last year. This initiative seeks to enable the students to handle all the details of media and journalistic work, starting from writing to direction. This serves as a practical training for the students under the supervision of the faculty's professors. In addition, the project was judged by a group of journalistic writers and professors, namely: Dr. Mahmoud Muslim, editor-in-chief of Al-Watan newspaper and member of the Senate, Prof. Akram Al-Qassas, editor-in-chief of Al-Youm Al-Sabaa newspaper, and Mr. Ali Mahmoud, managing editor of Al-Ahram e-portal.



URL: [Graduation Projects Judging In Techno-Hayat Magazine | Pharos University in Alexandria \(pua.edu.eg\)](https://pua.edu.eg)

### PUA Signs a Cooperation Protocol with Linguaphone British Institute for Languages

In pursuance of the field training plan of the Faculty of Language and Translation, PUA signed on Wednesday, June 8, 2022, a cooperation protocol with the Linguaphone British Institute for



Languages to train the students of the Faculty of Languages and Translation. It is worth noting that the Institute trains the students of the Faculty of Languages and Translation from all its departments in the following languages: “English, French, Turkish, Chinese, German, Japanese.”

This event was held in the presence of Prof. Dr. Ramadan Abu Al Ela, Vice President for Community Service and Environmental Development Affairs, Prof. Dr. Sahar Hamouda, Dean of the Faculty of Languages and Translation Mrs. Rania Bassiouni, Head of Field Training Unit and Mrs. Dina Ahmed Ghanem, Director of Linguaphone British Institute for Languages.





URL: [PUA Signs a Cooperation Protocol with Linguaphone British Institute for Languages | Pharos University in Alexandria](#)

### [Free General English Course for everyone](#)

Pharos University in Alexandria now offers a free Face-to-Face General English Course.

**Sunday to Thursday from 9:30 am to 11:45 am Egypt time**

For more information

Call: 033877347/217

WhatsApp: 01558357937

URL: [free General English Course for everyone | Pharos University in Alexandria \(pua.edu.eg\)](#)

### [Virtual Lecture on Pharmacognosy and Metabolomics](#)

In the context of its international cooperation with the University of Picardie Jules Verne (UPJV) – France, PUA’s Faculty of Pharmacy announces a virtual lecture on “Pharmacognosy and Metabolomics” on Wednesday, April 6, 2022 – 2:30 PM local time. The lecture, which is targeted to the sophomore students of Pharmacy D and Clinical Pharmacy Department, is hosted by Dr. Roland Molinie, Lecturer of Pharmacognosy and Metabolomics.





**Faculty of Pharmacy  
Pharos University in Alexandria**

In cooperation between  
Faculty of Pharmacy, Pharos University in Alexandria &  
Université de Picardie Jules Verne (UPJV) – France

Faculty of Pharmacy announces a virtual lecture for  
sophomore students entitled;  
**“Pharmacognosy and metabolomics”**

on **Wednesday 6<sup>th</sup> of April, 2022**  
from **2:30 – 4:30 PM** Egypt time

**Dr. Roland Molinié**  
**Lecturer of Pharmacognosy and Metabolomics**

URL: [Virtual Lecture on Pharmacognosy and Metabolomics | Pharos University in Alexandria \(pua.edu.eg\)](https://pua.edu.eg)  
[Faculty of Languages and Translation Holds an International Conference](#)

The Faculty of Languages and Translation held a 2-day international conference in collaboration with Trinity College, Dublin University entitled “Translation and Teaching: Challenges and Perspectives”. The conference had great feedback from 140 attendees from all around Egypt as well as attendees from Trinity College virtually. The conference dealt with a variety of topics on invitation methods of teaching and recent research on Translation. All abstracts were published in the conference procedures as well as keynote speakers’ abstracts. The conference held parallel sessions to cover a variety of topics. The attendees were thrilled by the organization, topics, and networking vibes.

Thank you note to all our sponsors: Capital Professional Development, American Council Egypt, IDP, and ECL Cambridge.



URL: [Faculty of Languages and Translation Holds an International Conference](#)



## [Faculty of Engineering Organizes a Workshop: Industry 4.0 and Digital Twinning in Effective Teaching](#)

Due to the implications of industry 4.0, major changes occurred to the businesses that strongly affected manufacturing processes and competitive features of local and international companies, industries, and systems.

In this regard, Faculty of Engineering, PUA organized a workshop that aims at contributing in the discussion on the effect of Industry 4.0 through surveying academic and industrial viewpoints. This can be done through the application of the technologies of the 21<sup>st</sup> century Industry 4.0. These technologies include Smart Manufacturing, Industrial Internet of Things, PC-based Controls, Autonomous Things (AuT), AR/VR, Artificial Things, which are considered the core of Industry 4.0.

The workshop was followed by a general lecture for the interested students to discuss a variety of major scientific topics such as (AI, Cloud Computing, Self-Driving Cars) and their relevance to the job market.

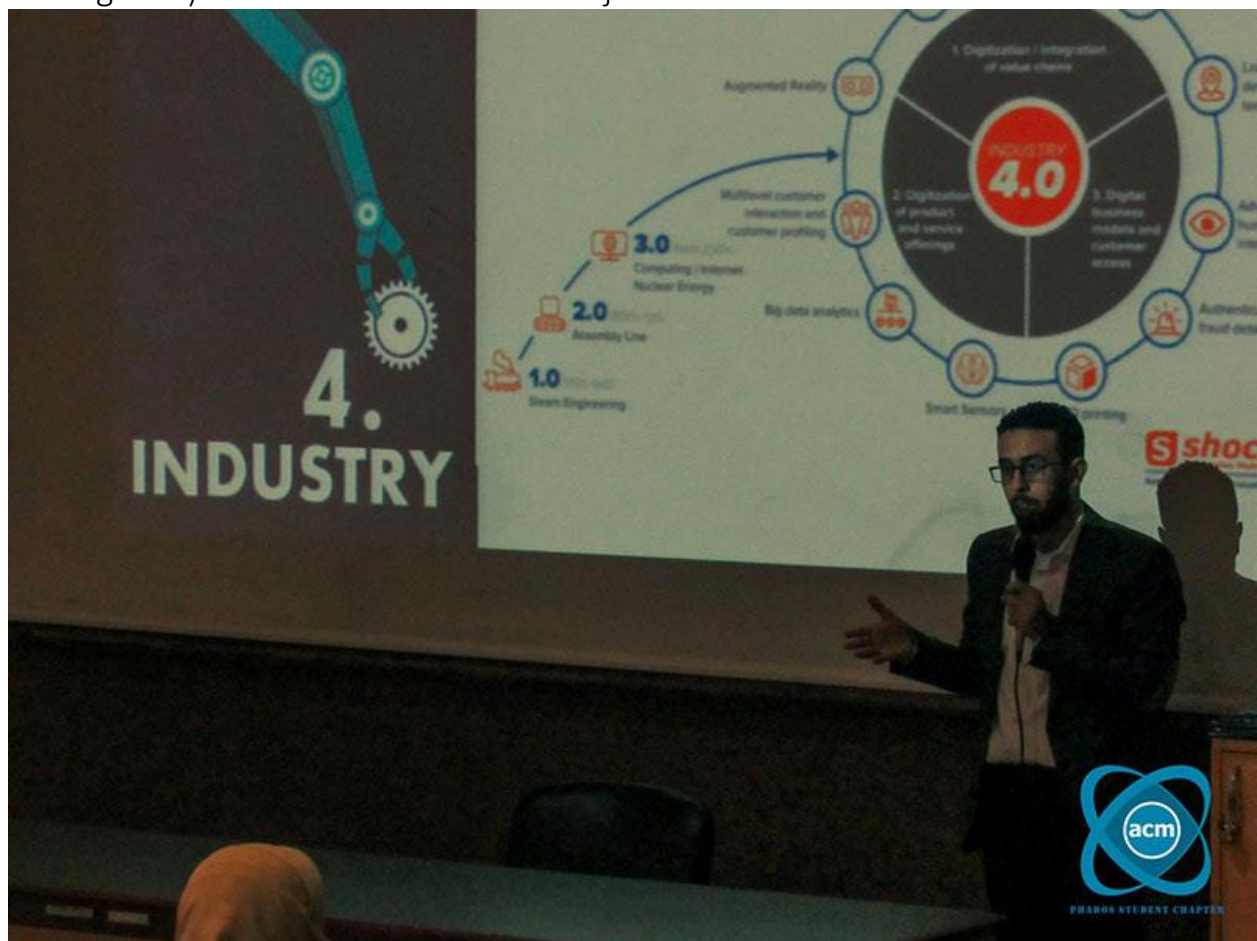

URL: [Faculty of Engineering Organizes a Workshop: Industry 4.0 and Digital Twinning in Effective Teaching | Pharos University in Alexandria \(pua.edu.eg\)](#)





### [PUA's Faculty of Engineering Sign a Cooperation Protocol with TÜV AUSTRIA](#)

In the context of supporting the academic study of the faculty students, providing them with practical and field experiences, and linking the curricula with industrial fields to achieve the sought integration, Prof. Dr. Mohamed Gaber Abou Ali, Dean of the Faculty of Engineering along with a group of the faculty professors welcomed Mr. Osama El-Sayed Ibrahim, Regional Director of TÜV AUSTRIA, on Wednesday, January 26, 2022. The meeting included the signing of a cooperation protocol between PUA's Faculty of Engineering and TÜV Austria.

In addition, during this meeting, aspects of cooperation between the two parties were tackled. These aspects included providing training opportunities and specialized workshops for the faculty students, providing experienced staff to supervise the students' research and projects at the faculty, which would provide solutions to some of the industry's problems. In a similar context, the faculty organizes training programs, workshops, conferences, and seminars for the company's employees. It also provides academic consultations considering the experience of its professors to solve some of the company's problems, which requires conducting research and studies in this regard.



URL: [PUA's Faculty of Engineering Sign a Cooperation Protocol with TÜV AUSTRIA | Pharos University in Alexandria](#)



### Collaborative interactive learning

The college of Tourism and Hotel Management, Pharos University in Alexandria, is adopting the COIL strategy (Collaborative Online International Learning) and is embedding it into its curriculum, supported by a rich international network of distinguished partners, including Universities, tourism organizations and independent professionals.

This approach is a globally widespread and recognized teaching method, supporting online interaction and collaboration between students from different countries as a virtual- mobility-and-exchange-based strategy, lead to quality enhancement of the education system as it provides students with an opportunity to interact with professors, professionals and peers at an international scale, to develop their intercultural competencies, digital skills and to allow them to learn from different international perspectives

URL:<https://www.pua.edu.eg/wp-content/uploads/2021/12/COIL-E.pdf>

### A Partnership between Pharos University in Alexandria (PUA), Egypt and TOI- OHOMAI Institute of Technology, New Zealand

Pharos University in Alexandria (PUA), Egypt, and TOI- OHOMAI Institute of Technology, New Zealand, have signed a Memorandum of Understanding intending to create a purposeful partnership and mutually beneficial cooperation in the fields of education, exchange of knowledge and collaborative research. The collaboration between both institutions is in various areas including Business Management, Hospitality and Tourism, and Information Technology.

TOI- OHOMAI Institute of Technology is a subsidiary of Te Pūkenga, New Zealand's largest tertiary education provider, with more than 12,000 students studying across various campuses in Rotorua, Taupō, Tauranga, Tokoroa and Whakatāne. PUA is the first private university in the North of Egypt located in the heart of the Mediterranean city of Alexandria. PUA's modern campus stretches over 50 acres to serve more than 15000 students across twelve faculties.

URL:[A Partnership between Pharos University in Alexandria \(PUA\), Egypt and TOI- OHOMAI Institute of Technology, New Zealand | Pharos University in Alexandria](#)



## [Pharos University Organized Meetings with KTH Royal Institute of Technology](#)

The International Relations Department organized many Zoom meetings between the academic staff of the Faculty of Engineering and KTH Royal Institute of Technology on 22-23 March, to track engineering students' exams. During these meetings, the exams' models and quality standards were discussed. It is worth mentioning that the teaching schedule has been approved for the next semester (spring 2020/2021).



URL: [Pharos University Organized Meetings with KTH Royal Institute of Technology | Pharos University in Alexandria \(pua.edu.eg\)](#)





## Pharos University Participated in Africa Higher Education Webinar

Pharos University participated in a webinar entitled “Towards Linked Africa Higher Education: Windows of Opportunities” organized under the supervision of the Association of African Universities’ North Africa Regional Office “AAU-NARO”. This was held on Wednesday, 17 March 2021. It is worth mentioning that more than 20 African universities participated in the webinar including Pharos University which was represented by Prof. Boshra Salem, Dean of Postgraduate Studies and Research in Pharos University and Dr. Mennatallah Gowayed, the PUA International Relations Coordinator.

During the webinar, on behalf of PUA president Prof. Boshra Salem gave a speech to representatives of “NARO” and participating universities and thanked “NARO” for inviting Pharos University to be a part of activities to mark NARO’s two years’ anniversary. This was followed by a presentation by Dr. Mennatallah Gowayed on PUA international relations specially with the Corona circumstances. It is worth mentioning that Pharos University is the only Egyptian university presented the topic of internationalization and international relations.

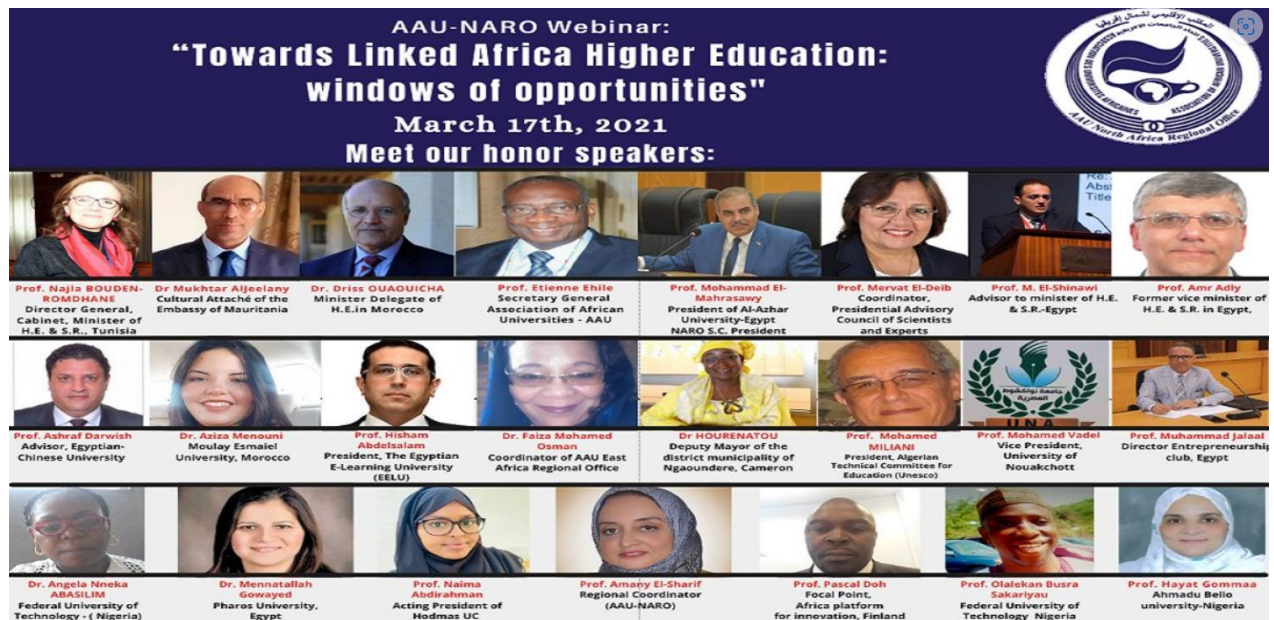

URL: <https://www.pua.edu.eg/pharos-university-participated-in-africa-higher-education-webinar/>



## [Pharos University Received the Director of the Japan Foundation in Cairo](#)

Pharos University welcomed Mr. Yoo Fukazawa, the Director of the Japan Foundation in Cairo on Sunday, 21 February 2021. He was received by Prof. Mahmoud Mohy El Din, the President of Pharos University, Prof. Sahar Hamouda, the Dean of the Faculty of Languages and Translation, Dr. Mohamed Abdel Fattah Ragab, the Secretary General and Dr. Mennatallah Gowayed, the PUA International Relations Coordinator. They discussed way of teaching Japanese Language in PUA through courses supervised by the Japan Foundation. At the end of the day, Dr. Mohamed Abdel Fattah Ragab, the Secretary General presented the university shield to Mr. Yoo Fukazawa.



URL: [Pharos University Received the Director of the Japan Foundation in Cairo](#)



## [A New Partnership between PUA and Trinity College Dublin](#)

Pharos University in Alexandria (PUA), Egypt, and Trinity College Dublin (TCD), Ireland, have signed a Memorandum of Understanding to inaugurate their new partnership. The collaboration between both institutions is in the field of Applied Linguistics and includes mutual engagement in undergraduate education, postgraduate studies, and research. Founded in 1592, Trinity is Ireland's highest ranked university and has produced some of the world's finest writers such as Oscar Wilde and Samuel Beckett, a Nobel Prize Laureate. Trinity's School of Linguistic, Speech and Communication Sciences is an internationally recognized reference point for the scientific study of language, characterized by an emphasis on communication diversity and inclusion, fostering critical curiosity, a nurturing learning environment, and working collaboratively.

Professor Mahmoud Mohy El Din, PUA President, expressed his deep satisfaction with the agreement stating, "Trinity College Dublin is a wonderful partner and this step reflects our strategy for internationalization and cooperation with top ranked universities to exchange knowledge and culture." "We are very excited to extend our work with Trinity College Dublin" added Professor Sahar Hamouda, Dean of the Faculty of Languages and Translation at PUA, "This cooperation will enable us to further develop our teaching of Applied linguistics and expose our staff and students to distinguished expertise from Ireland through the planned academic exchange activities. I would like to sincerely thank Dr. Lorna Carson for her great effort in moving our collaboration forward particularly in a year that was challenged with all the uncertainties of the pandemic."

From Trinity's side, Dr. Lorna Carson stated, "I welcome this deepening collaboration between our School and the Faculty of Languages and Translation at PUA. Our joint expertise in Applied Linguistics makes this a very meaningful partnership and we look forward to working closely with staff and students from PUA over the coming years."

PUA is the first private university in the North of Egypt located in the heart of the Mediterranean city of Alexandria. PUA's modern campus stretches over 50 acres to serve more than 13000 students across twelve faculties. The PUA Faculty of Languages and Translation offers degrees in English, French, Chinese, Spanish and Turkish language in addition to German and Italian as second languages. With





a broad background in culture studies, vigorous training in language and translation skills, and integration of technology-based teaching methodologies, the faculty arms students with knowledge and skills for a global job market.



URL: [A New Partnership between PUA and Trinity College Dublin | Pharos University in Alexandria](#)

### Confucius Announcement

The International Relations Department – Pharos University in Alexandria in cooperation with Confucius institute in Cairo announces the opening of registration for the Chinese language online course (July 2020) from 14th to 30th June 2020, note that this course will begin on Saturday, 4 July 2020.

To register please head to the International Relations office in The Administrative Building – third floor from 10 am to 1:30 pm.

URL: [Confucius Announcement | Pharos University in Alexandria \(pua.edu.eg\)](#)



## [A Delegation from the University of Malaga in a Visit to Pharos University](#)

Under the cooperation agreement signed lately between Pharos University and the Faculty of Tourism at the University of Malaga (UMA, Universidad de Málaga), the faculty of Tourism and Hotel Management at Pharos University received a delegation from UMA on Monday, 24 February 2020.

The delegation was comprised of:

- Antonio Guevara, the Dean of faculty of Tourism at the UMA.
- Antonio Peláez, the UMA International Relations Coordinator.

The delegation was received by:

- Mahmoud Mohy El-Din, the President of Pharos University.
- Norhan Fanaky, the Vice-President for Education and Student affairs.
- Mona Barakat, the Dean of the Faculty of Tourism and Hotel Management in PUA.
- Menatallah Goweyad, the PUA International Relations Coordinator.
- Tamer El Sawy, the faculty International Relations Coordinator.
- Assistant Lecturer Basant Shahin, the faculty International Relations Coordinator.
- Faculty members and teaching assistants.

This three-day visit included several meetings to discuss future cooperation in the field of tourism and hotel management between the two parties. The delegation was also introduced to the facilities of the university which they praised.



URL: [A Delegation from the University of Malaga in a Visit to Pharos University | Pharos University in Alexandria \(pua.edu.eg\)](#)



## [A KTH High-level Delegation in a Visit to Pharos University](#)

Under the cooperation agreement signed between the KTH Royal Institute of Technology in Sweden and Pharos University, the faculty of Engineering received a delegation of eight KTH faculty members on Sunday, 23 February 2020 in a four-day visit. It is worth mentioning that the delegation was comprised of the following:

- Associate Prof. Albania Nissan, the PUA-KTH Project Leader.
- Göran Engdahl, the Coordinator of the Electrical Engineering Program.
- Björn Palm, the Coordinator of the Mechanical Engineering Program.
- Yohannes Kiros, the Coordinator of the Petrochemical Engineering Program.
- Johan Karlander, the Coordinator at the Computer Engineering Program.
- Daniel Tesfamariam Semere, the Coordinator of the Production Engineering Program.
- Raied Karoumi, the Coordinator of the Structural Engineering and Bridges Program.

The program of the visit featured several lectures for the students of the faculty of Engineering and a workshop for the academic staff members of the Electrical Engineering Department. In addition, several meetings were held between the delegation and the faculty senior academic staff to discuss and follow up the proceedings of the joint program.



URL: [A KTH High-level Delegation in a Visit to Pharos University | Pharos University in Alexandria \(pua.edu.eg\)](#)





## [Pharos University Organizes Two Workshops on the Sidelines of the 2nd International Conference of the Faculty of Pharmacy and Drug Manufacturing](#)

On the sidelines of the 2<sup>nd</sup> international conference of the faculty of Pharmacy and Drug Manufacturing, two workshops are organized on 9-10 March 2020 from 9 am to 4 pm. The first workshop is on “How to Implement Flipped Classroom Approach in University Courses” and delivered by Prof. Markku Saarelainen, a Professor of Physics at University of Eastern Finland (UEF) and a Professor of Practice at Tampere University (TAU) in Finland.

Meanwhile, the second workshop which is about “Synthesis, Processing, Characterization and Functional Validation of Inorganic Nanomaterials for Bio-applications”, is delivered by Prof. Muhammet Toprak, a Professor of Materials Chemistry, Nanochemistry Research Group in the KTH -Sweden. For registration, please contact us on [icmaps.international@pua.edu.eg](mailto:icmaps.international@pua.edu.eg)

DEPARTMENT OF INTERNATIONAL RELATIONS

# UPCOMING WORKSHOPS

MARCH 2020

**Prof. Markku Saarelainen**  
UNIVERSITY OF EASTERN FINLAND  
University Lecturer in Physics, University of Eastern Finland (UEF) and Professor of Practice Tampere University (TAU), Finland

**Prof. Muhammet Toprak**  
KTH  
Professor of Materials Chemistry, Nanochemistry Research Group, KTH, Sweden

**How to implement Flipped Classroom in university courses** MARCH 9, 2020 9 am - 4 pm  
The workshop is about implementation of the flipped classroom method in practice. In the workshop I will go through my “teachers guidebook”, useful tips and technology that we have used in the Finnish universities. According to my experience, my examples and methods of instruction initiates discussion and rises questions. I would gladly use time to deepen the concept of using flipped classroom based on the participants demands and their wishes.

**Synthesis, processing, characterization and functional validation of Inorganic Nanomaterials for bio-applications** MARCH 10, 2020 9 am - 4 pm  
The workshop aims at providing an overview of i) Inorganic Nanomaterial architectures; ii) Inorganic Nanomaterials in medicine; iii) Solution based Inorganic Nanomaterial synthesis strategies; iv) Basic Solution thermodynamics, solubility, K<sub>sp</sub>, pH concepts; and v) provide software training on water based solution thermodynamics calculations for design of simple experiments for nanomaterial synthesis.

For registration please contact us through email : [icmaps.international@pua.edu.eg](mailto:icmaps.international@pua.edu.eg)

URL: [Pharos University Organizes Two Workshops on the Sidelines of the 2nd International Conference of the Faculty of Pharmacy and Drug Manufacturing | Pharos University in Alexandria \(pua.edu.eg\)](#)



## [A Delegation of Yunnan University in a Visit to Pharos University](#)

Pharos University received a high-level delegation of Yunnan University in China on Tuesday, 14 January 2020. The delegation was comprised of Prof. Hussien Ibrahim, the former Cultural Attaché of Egypt in the People's Republic of China and a Consultant to Pharos University on Egyptian-Chinese relations. The delegation was received by Prof. Mahmoud Mohy El Din, the President of Pharos University; Prof. Nourhan Fanaky, the Vice President of Education and Student Affairs; Prof. Tarek Taha, the Dean of the Faculty of Financial and Administrative Sciences; Prof. Mohamed Gaber, the Dean of the Faculty of Engineering; Prof. Leyal Kamel, the Dean of the Faculty of Languages and Translation; Prof. Nahed Abdallah, the Head of the Chinese Language Department at the Faculty of Languages and Translation; Prof. Wael Moustafa, the Vice Dean of the Faculty of Financial and Administrative Sciences and the Faculty International Relations Coordinator; Dr. Mohamed Abdelfattah Ragab, the Secretary General and Dr. Mennatallah Gowayed, the PUA International Relations Coordinator. The visit featured discussing many topics, including seeking means of cooperation between Yunnan University and the Chinese Language Department and other faculties of Pharos University.



On their part, the delegation of the Chinese University expressed their approval of launching a student exchange programme between the two universities to open an opportunity for PUA students to study business administration at Yunnan University in China.



This was in addition to implementing a faculty exchange programme in different specializations with the aim of exchanging expertise between the two parties. At the end of the visit, Prof. Mahmoud Mohy El Din presented the university plaque to the representatives of Yunnan University.

URL: [A Delegation of Yunnan University in a Visit to Pharos University | Pharos University in Alexandria \(pua.edu.eg\)](https://pua.edu.eg)



## SDG 5 – Gender Equality

Sustainable Development Strategy (Egypt's Vision 2030) entails a strategic vision, which is to provide a high-quality education and training system for all, without discrimination. With this vision, students and trainees are provided with the necessary skills to help them think creatively and empower them technically and technologically; and contribute to the development of proud, creative, responsible, and competitive citizens who accept diversity and differences, are proud of their country's history, and are eager to build its future and can complete with regional and international entities.

Pharos University is committed to the state Constitution regarding the place of women, motherhood, and childhood. (Article 11, Page 13).

According to the national constitution Article 11: The place of women, motherhood, and childhood ([https://www.constituteproject.org/constitution/Egypt\\_2014?lang=en](https://www.constituteproject.org/constitution/Egypt_2014?lang=en)). It states that:

- “the state commits to achieving equality between women and men in all civil, political, economic, social, and cultural rights in accordance with the provisions of this Constitution. • Equality regardless of gender the state commits to taking the necessary measures to ensure appropriate representation of women in the houses of parliament, in the manner specified by law. • It grants women the right to hold public posts and high management posts in the state, and to appointment in judicial bodies and entities without discrimination. First chamber representation quotas and Second chamber representation quotas
- The state commits to the protection of women against all forms of violence and ensures women empowerment to reconcile the duties of a woman toward her family and her work requirements. • The state ensures care and protection and care for motherhood and childhood, and for breadwinning, and elderly women, and women most in need”.

Pharos University agrees with the UN's statements on the importance of ensuring that all people, including women and girls, have access to quality education, healthcare, and economic opportunity. They're essential to maintaining thriving economies and providing overall benefits to communities and humans.



Since Pharos University's inception, efforts have been made to ensure that male and female students have equal opportunities to succeed academically.

### 5.1 Statistics (Students, Graduates, Postgraduates, Academic Staff and Employees)

This report is compiled annually and includes information on the total number of students, postgraduates, full-time employees, and full-time equivalents (FTEs) for part-time employees. To keep up with global norms and guarantee that there is no gender disparity in women enrolment ratio at all levels, Pharos University uses these annual counts to track the percentage of female students. The ratio of male to female students at each grade level is analyzed for internal efficiency to determine if there is a significant gender gap.

All the data presented in this report is supplied by managers of different departments and is analyzed, interpreted, and presented by the author of this report.

The statistical data can be found in the full report ([SDG-5-Report-Final.pdf](#))

### 5.2 Special Women Events

#### **Faculty of Tourism and Hotel Management a Mother's Day**

The Faculty of Tourism and Hotel Management organized a Mother's Day celebration on Tuesday, March 22, 2022, from 1 pm to 2.30 pm in Room D609 of PUA's theoretical building. The event was opened with a speech delivered by Prof. Dr. Muhammad Nassar, faculty supervisor, where he thanked the female employees for their efforts throughout the year. Later, the mothers working in the faculty were honored for maintaining the cohesion of their families, taking care of their children, and standing against the challenges and difficulties.

URL: <https://www.pua.edu.eg/faculty-of-tourism-and-hotel-management-a-mothers-day/>





### **Faculty of Engineering Visits a Nursing Home**

Within the framework of Pharos University's keenness to play its role in community service, the Community Service Committee of the Faculty of Engineering, in cooperation with the Student Activities Committee and the Khair Team Family, organized a visit to the Health Improvement Home in Al Ras Al sawdaa on Sunday, March 27, 2022. The visit was under the supervision of the Activities Department, along with a number of Faculty students and Khair Team Family, with the supervision of Eng. Amr Mamdouh, Teaching Assistant, Department of Mechanical Engineering, Faculty of Engineering. The students celebrated with the home mothers on Mother's Day. Further, memorial photos were taken in an atmosphere full of intimacy and affection, while observing all precautionary measures.

URL: <https://www.pua.edu.eg/faculty-of-engineering-visits-a-nursing-home/>





### **Inclusion of an Egyptian Scientist from Pharos University in Alexandria Scientists in the Updated Science Wide Author Databases of Standard Citation Indicators**

The name of Dr. Yousra El-Naggar, Associate professor of Pharmaceutics and Pharmaceutical Technology, has been included in the "Updated Science Wide Author Databases of Standard Citation Indicators" which is based on citation index and H-index, she has obtained her Ph.D. from Alexandria University, and currently is an associate professor in Pharos university in the field of pharmaceutical technology.

Dr. El- Naggar has published 39 research papers in her profession and these publications have received 1177 international citations, Her H- index is 20, according to Scopus database of Elsevier publication firm. Dr. El-Naggar was awarded several national and international awards and medals, the latest and most prestigious is "first class excellence medal from Egyptian presidency" in 2019.



#	A	B	C	D	E	F	G	H	I	J	K	L	M	N	O	P
11221	Garcia-Perez, Jose Vicente	Universitat Politècnica de València	esp	102	2004	2020	116119	646	13	6.972016	0	0	20	115	43	31
11222	Chen, Xu	Tianjin University	chn	285	1994	2020	116120	702	11	6.841667	0	0	33	116	164	42
11223	Reinhold-Hurek, Barbara	University of Bremen	deu	88	1992	2020	116121	574	12	5.983246	0	0	14	171	67	40
11224	Sun, Young	Chinese Academy of Sciences	chn	165	1999	2020	116125	724	13	5.798172	0	0	27	107	91	48
11225	Mokenna, D. D.	University of Memphis	usa	41	2001	2020	116126	487	9	4.946485	3	8	16	137	30	19
11226	Oikawa, K.	Tohoku University	jpn	208	1994	2020	116127	942	14	5.436183	0	0	41	143	67	29
11227	Rossi, Mauro	Consiglio Nazionale delle Ricerche	ita	87	2007	2020	116128	554	17	6.497619	0	0	14	78	30	21
11228	Dolara, Piero	Università degli Studi di Firenze	ita	230	1971	2016	116129	494	10	4.819896	5	10	47	60	141	22
11229	Chen, Wei Neng	South China University of Technology	chn	103	2005	2019	116130	722	15	6.009524	0	0	15	171	21	19
11230	Elmaggar, Yosra S.R.	Pharos University in Alexandria	egy	31	2009	2020	116131	259	10	5.416667	1	11	12	128	13	18
11231	Sadikot, Ruxana	Emory University School of Medicine	usa	123	1997	2020	116132	452	10	5.988716	6	1	34	96	70	28
11232	Henry, Gerard D.	ArkLaTex Urology	usa	63	2000	2020	116134	266	9	4.936404	3	16	24	106	39	16
11233	Lu, Minghua	Henan University	chn	87	2007	2020	116135	534	13	5.720587	1	5	17	66	29	34
11234	Jodoin, B.	University of Ottawa, Canada	can	107	1998	2020	116136	407	12	6.57619	2	7	10	30	63	25
11235	Amico, S. C.	Universidade Federal do Rio Grande	bra	215	1998	2020	116137	780	14	7.67619	2	0	14	42	142	50
11236	Ehde, D. M.	University of Queensland	aus	139	1991	2020	116138	679	12	6.575397	1	0	27	172	53	26
11237	Regad, Tarik	Nottingham Trent University	gbr	27	2001	2020	116139	236	7	3.978268	2	67	10	87	19	13
11238	Powell, F. C.	University College Dublin	irl	142	1979	2019	116140	344	9	4.652381	14	18	58	55	117	25
11239	Roy, Kinshendu	Georgia Institute of Technology	usa	115	1996	2019	116142	695	15	6.546522	2	0	9	63	82	46

URL: <https://www.pua.edu.eg/inclusion-of-an-egyptian-scientist-from-pharos-university-in-alexandria-scientists-in-the-updated-science-wide-author-databases-of-standard-citation-indicators/>

### 5.3 Women Mentoring Schemes

Pharos university is supporting students and staff members through various training programs and Skill set to improve their self-sustain of personal and academic development paths through two departments inside Pharos Institution.

#### Educational Development Center:

The Education Development Center (EDC) at Pharos University in Alexandria is an academic center concerned with the continuing development of its staff members' skills and understanding in key areas of teaching, learning, assessment and quality assurance. The EDC's main goal is to promote and enhance students' engagement in the learning process and to create an interactive learner-centered atmosphere that ensures the ongoing improvement of students' performance and skills. The Objectives of the EDC are:

Creating a positive learning environment within the institution, in which teaching and learning methods can flourish.

- Helping and encouraging educators to shape and develop their teaching in response to the needs of their learners, their institution, and local and national priorities.
- Meeting the needs of new instructors, trainers, and tutors to engage them



with confidence, into positive effective roles in education.

- Assisting in the design and implementation of courses curriculum and training programs;
- Assessing students' satisfaction with the educational process and accordingly, the renewal of the faculty educational strategic plan.
- Designing educational activities that advance staff members professional knowledge and skills pertaining to a high-quality educational environment.
- Coordinating the center activities with the activities of other university centers, units, and departments to enhance the quality of educational process.

Academic Staff (2021-2022)				
Faculty	Male Staff Members	Female Staff Members	Total Staff Members	Ratio Male: Female
Pharmacy and Drug Manufacturing	12	46	58	1:3.83
Dentistry	16	24	40	1:1.5
Engineering	22	32	54	1:1.45
Financial and Administrative Sciences	3	5	8	1:1.67
Languages and Translation	2	5	7	1:2.5
Legal Studies	7	0	7	1:0
Tourism and Hotel Management	4	2	6	1:0.5
Physical Therapy	7	15	22	1:2.14
Mass Communication	7	3	10	1:0.43
Applied Health Sciences Technology	14	20	34	1:1.43
Arts and Design	2	30	32	1:15
Computer Science and Artificial Intelligence	3	2	5	1:0.67
<b>Total</b>	<b>99</b>	<b>184</b>	<b>283</b>	<b>1:0.68</b>

**Table 6.A. The Count of Teaching staff members who attended course for educational and personal Development**

Assistant Staff (2021-2022)				
Faculty	Males TA Members	Females TA Members	Total TA Members	Ratio Male: Female
Pharmacy and Drug Manufacturing	4	48	52	1:12
Dentistry	14	33	47	1:2.36
Engineering	22	39	61	1:1.77
Financial and Administrative Sciences	1	10	11	1:10
Languages and Translation	0	22	22	
Legal Studies	7	5	12	1:0.71
Tourism and Hotel Management	5	2	7	1:0.4
Physical Therapy	11	22	33	1:2
Mass Communication	2	13	15	1:6.5
Applied Health Sciences Technology	6	18	24	1:3
Arts and Design	3	25	28	1:8.33
Computer Science and Artificial Intelligence	1	6	7	1:6
<b>Total</b>	<b>76</b>	<b>243</b>	<b>319</b>	<b>1:7</b>

**Table 6.B. The Count of Teaching Assistants members who attended course for educational and personal Development**



### The Career Development and Entrepreneurship Center (CDEC)

The career development and entrepreneurship center at Pharos University in Alexandria is committed to provide a solid foundation of career development principles, professional career guidance and employment services to students, alumni and employers through a centralized, comprehensive program.

Number of Students joining Career Development and Entrepreneurship Center:

Academic Year	Males	Females	Total
2020-2021	174	670	844
2021-2022	195	409	604
<b>Total</b>	<b>369</b>	<b>1079</b>	

Table 7.A. The Count of Students members who are joined to career and development entrepreneurship center (CDEC)

Number of Students and Staff Members and outsiders joining Career Development and Entrepreneurship Club:

<b>Club Members</b>	
Number of Students that their membership has registered to the club	193
Number of Students Family Members	24
Number of Staff and Teaching assistants that had been registered to the Club	22
Number of Employees that had been registered to the club	15
<b>Number of beneficiaries from club activities</b>	
Number of Teaching Staff members and teaching assistant members that had been trained	36
Number Students that had been trained	1180
Number of Male students that had been participated with the club activities	445
Number of Female Students had been participated with the club activities	735
<b>Competitions</b>	
Number of Students participated in the university's internal Competitions	103
Number of Students participated in Local Egyptian Competitions	42
Number of Students participated International Competitions	28





Club Members	
Number of beneficiaries from outside of Pharos University	
Valley of Science and Technology in Zewail City	13
Alexandria Higher Institute of Engineering and Technology	8
University Of Sadat City	20

**Table 7.B. The Count of Students and Staff members who registered to career and development entrepreneurship Club**

### Entrepreneur fair in December 2021

Number of Participating Projects in Entrepreneur fair in December 2021	23 Projects	
	Male	Female
The number of Entrepreneur participated in the entrepreneur Fair Knowing that there are many entrepreneurs has more than one project	5	23
The number of Students Entrepreneur participated in the entrepreneur Fair Knowing that there are many entrepreneurs has more than one project	2	9
The number of Graduate Students Entrepreneur participated in the entrepreneur Fair Knowing that there are many entrepreneurs has more than one project	3	14

## 5.4 Scholarships

Pharos University offers several scholarships every year to enable students continuing their higher education and give access to women to empower in their career. This year 2023 Pharos Offered 32 Scholarship for students and the most of scholarships were awarded at medical sciences and Engineering ([SDG-5-Report-Final Page 23.pdf](#))



## 5.5 Conclusions and Appendix

1. Women are well presented in all disciplines of the University. They have equal rights and foot to men in education rights, jobs, research, and participation in all activities.
2. Women are included in senior jobs at the administrative faculty and university levels.
3. Women in Pharos University are subject to maternity and paternity policies that support their inclusion in all workplaces with equal rights to men according to the Women national bylaws (Appendix)  
<https://www.pua.edu.eg/wpcontent/uploads/2019/12/Policy-Statements-2018.pdf>
4. Women in Pharos University are on equal pay scale equity including commitment to elimination of gender pay gaps in accordance with the annual track measure of the pay scale equity.

Appendix 1: Registered Students in the First Academic (Freshmen) per year from 2006 to 2023 ([SDG-5-Report-Final Page 25.pdf](#))

Appendix 2: Policy Statements ([Appendix-2.pdf](#))

Appendix 3: Women Bylaws to Support their Participation at Work ([SDG-5-Report-Final Page 30.pdf](#))





## SDG 6 – Clean Water and Sanitation

### 6.1 Pharos University Efforts

Pharos University in Alexandria is paying a lot of attention to the clean water and sanitation issues. This is in the form of initiatives, courses, projects, and cooperation agreements. The following are some examples of the university's efforts to address clean water and sanitation.

#### 1) Pharos Contributions in the “Live Green” Presidential Initiative with a study on “Harmonic Mechanisms for Treating all Types of Wastewaters to Irrigate a Sustainable Green Belt to Protect the Vicinity of Lake Mariout.”

Prof. Ramadan Abu El-Ala, the Vice President of Community Service and Environment Development Affairs and Prof. Hesham El Shimy, the Director of the Community Service and Environmental Development Centre (CSED) participated in a meeting about the “Live Green” initiative. The meeting was held in Alexandria Governorate Office on Wednesday, 12 February 2020.

The meeting was attended by Mr. Ahmed Gamal, the Deputy Governor of Alexandria, and representatives from all concerned authorities in the governorate. This meeting aimed to discuss the mechanisms to apply the “Live Green” initiative launched by the President of Egypt to raise environmental awareness in Alexandria. During the meeting, Mr. Ahmed Gamal stressed the importance of the consultative role of Pharos University which came within the framework of the government keenness to achieve cooperation and integration by taking advantage of the experiences of the scientific bodies in Alexandria and working hand in hand for the benefit of the governorate.

In addition, Prof. Hesham El Shimy showed the attendees a study on “Harmonic Mechanisms for Treating all Types of Wastewaters to Irrigate a Sustainable Green Belt to Protect the Vicinity of Lake Mariout.” It is worth mentioning that the study impressed all the attendees, and it was stressed upon the need for adopting that study by the governorate and other authorities at the local and central levels. At the end, the Deputy Governor asked for an electronic copy of the study to put it into practice.



*Evidence url:*

<https://www.pua.edu.eg/pharos-contributions-in-the-live-green-presidential-initiative/>

#### 4) Improving the Performances of Cellulose Acetate membrane for Water Desalination by doping Nano-graphene Oxide: “Towards a Sustainable Tomorrow” competition

“Towards a Sustainable Tomorrow” annual competition was held at PUA’s Faculty of Engineering, under the auspices and support of Birla Carbon.

The competition was opened at 9:30 am with a speech from Prof. Dr. Muhammad Gaber Abu Ali, Dean of the Faculty of Engineering. After that, the senior students presented their competing projects Four academic departments participated in the competition, namely:

- Petrochemical Engineering Department (two projects)
- Mechanical Engineering Department (four projects)
- Electrical Engineering Department (two projects)
- Construction Engineering and Management Department (two projects)

Together, the competing projects reached 10 projects and were evaluated by a jury comprising of:

- Dr. Mona Gamal El-Din, Dean of the Faculty of Energy, Environmental and Petrochemical Engineering, Egyptian Japanese University
- Dr. Boshra Salem, Dean of Graduate Studies and Research Affairs
- Dr. Mohamed Naim Anwar, Vice Dean of the Faculty of Engineering for Education and Student Affairs
- Dr. Wael El-Maghlany, Head of the Mechanical Engineering Department, Faculty of Engineering, Alexandria University.



Further, the faculty members who supervised the graduation projects along with the competing students were honored and awarded certificates of appreciation. At 2 pm, the results were declared and in the first place came the Petrochemical Engineering Department with a project entitled “Improving the Performances of Cellulose Acetate membrane for Water Desalination by doping Nano-graphene Oxide”. This project was supervised by Dr. Aya Suleiman and Dr. Ashraf Morsi and was awarded a prize money of EGP 17,000.



**Evidence url:**

<https://www.pua.edu.eg/towards-a-sustainable-tomorrow-competition/>



### 3) University management plan for water conservation:

Pharos University is implementing a plan for the re-use of water in its premises:

- (a) Wastewater and as per the records of the University Administration:  
Wastewater from washing rooms, kitchens, and laboratories are collected and channeled to a specialized company to manage the recycling process and get rid of toxic material in a safe way. The University has signed a contract with a specialized company for collection and treatment of wastewater in a sustainable way. This company was selected based on its environmental portfolio that ensures that water is reused in an environment friendly way. The company is responsible to treating water for reuse according to the quality of output, mainly in irrigating street trees in the neighborhood.
- (b) Reuse of water: The University manages a process for rainwater collection and fresh water disposed from air-condition units. Both water sources are channeled and stored in a 15m<sup>3</sup> water tank for reuse in irrigation of the landscape, and the green playgrounds that reach an area of about 35200 m<sup>2</sup>. This green area has increased since last year where it was 21000 m<sup>2</sup>. With this amount of water, the green areas in Pharos University is expected to increase every year.
- (c) Drinking water: Drinking water quality is maintained at the University premises by installing 3-level filters at the source inlet to purify drinking water before use by university members. The amount of freshwater reuse in the campus has decreased due to the above practices. The current average amount is about 2779 m<sup>3</sup> per month.



## 6.2 Courses in Curricula

No	Faculty in Pharos University	Course name	Course code	SDG of relevance	Topics in each course
1	Applied Health Sciences Technology	Environmental Health	MGEH-101	SDG 6	Hygiene for Clean water and sanitation
2	Pharmacy	Instrumental Analysis	(PCD 203)	SDG 6	methods of water purification, the detection of impurities
3	Engineering	Water and Wastewater	ES 401	SDG 6	The course introduces an overview of Water Supply Introduction and Definitions, important Fields of Environmental Engineering, Environmental system, Waste cycles
4	Engineering	Water treatment	EP 328	SDG 6	This course introduces the students to Water chemical analysis, water treatment for different uses, Equipment design calculations





### 6.3 Publications

No	TITLE/YEAR/AUTHORS	DOI
1.	Development of cellulose acetate membrane performance by carboxylate multiwalled carbon nanotubes 2022 Fadl, E.   Noumir, H.   Morsy, A.   Kandil, S.   Ebrahim, S.   Khalil, M.M.A. Advances in Natural Sciences: Nanoscience and Nanotechnology	10.1088/2043-6262/ac53ff
2.	Optimized Degradation of Eosin Dye Through UV-ZnO NPs Catalyzed Reaction 2022 Farouq, R.   Ismaeel, E.K.   Monazie, A.M. Journal of Fluorescence	10.1007/s10895-022-02889-3
3.	Improved anti-biofouling resistances using novel nanocelluloses/cellulose acetate extracted from rice straw based membranes for water desalination 2022 Morsy, A.   Mahmoud, A.S.   Soliman, A.   Ibrahim, H.   Fadl, E. Scientific Reports	10.1038/s41598-022-08324-8
4.	Investigation of Biosurfactants Production from Petroleum Oil Wastes Using Response Surface Methodology 2022 Tayeb, A.M.   Mostafa, N.A.   Olfat, M.A.   Farouq, R.   Monazie, A.M. Petroleum Chemistry	10.1134/S0965544122020256
5.	Adsorption study of bisphenol-A and chlorpyrifos onto nanobentonite intercalated with magnetite and sodium alginate: kinetics and isotherm models 2022 El-Sharkawy, R.M.   Allam, E.A.   Ali, A.S.M.   Mahmoud, M.E. International Journal of Environmental Science and Technology	10.1007/s13762-021-03815-z
6.	Treatment by agricultural by-products of Industrial effluents polluted with heavy metals 2022 Tayeb, A.M.   Farouq, R.   Mahmoud, M.A.   Daher, A.M.   Amer, T.E.   Magdy, Y.H. Indian Journal of Chemical Technology	-



No	TITLE/YEAR/AUTHORS	DOI
7.	New Sustainable Agenda for Slums Future Expansion, Case-Study: Ezbiit El-Matabea, Alexandria, Egypt 2022 Ragheb, R.A.   Barakat, P.N. International Journal of Sustainable Development and Planning	10.18280/ijSDP.170204
8.	Chitosan based adsorbents for the removal of phosphate and nitrate: A critical review	10.1016/j.carbpol.2021.118671
9.	[HTML] Performance evaluation of continuous solar still water desalination system	10.1007/s10973-020-09547-5
10.	Framework of nano metal oxides N-NiO@ N-Fe <sub>3</sub> O <sub>4</sub> @ N-ZnO for adsorptive removal of atrazine and bisphenol-A from wastewater: Kinetic and adsorption studies	10.1016/j.enmm.2021.100481
11.	[HTML] Hybrid renewable energy/hybrid desalination potentials for remote areas: selected cases studied in Egypt	10.1039/d1ra00989c
12.	[HTML] Assessment of spatiotemporal patterns of social vulnerability: A tool to resilient urban development Alexandria, Egypt	10.1016/j.asej.2020.07.025
13.	Water treatment from MB using Zn-Ag MWCNT synthesized by double arc discharge	10.3390/ma14237205
14.	Novel sea water desalination unit utilizing solar energy heating system 2020 ElHelw, M.   El-Maghlany, W.M.   El-Ashmawy, W.M. Alexandria Engineering Journal	10.1016/j.aej.2020.03.019
15.	Enhanced solar desalination units 2020 Tayeb, A.M.   Farouq, R.   Shehata, A.Z.   Othman, R.H. Proceedings of Institution of Civil Engineers: Energy	10.1680/jener.19.00065
16.	Use of hydrazide derivative of poly methylacrylate for the removal of cupric ions from solutions 2020 Mahmoud, A.   Nassef, E.   Salah, H.   El-Taweel, Y. AIMS Materials Science	10.3934/MATERSCI.2020.4.420



## SDG 7 – Affordable and Clean Energy

### 7.1 Pharos University Efforts to Address Energy

Pharos University in Alexandria is paying a lot of attention to affordable and clean energy issues. This is in the form of initiatives, courses, events, projects, and cooperation agreements. The following are some examples of the university's efforts to address energy.

### 7.2 Students’ Projects

#### 1) Students’ Field Projects Addressing Energy at Pharos University:

Students contributes with the following projects in the field of energy

No	Project Name	Summary
1	Natural Fibers	The usage of natural resources will play a leading role in the sustainable development of the cement and concrete industry during this century. Plant-based natural fibers are used more increasingly in construction materials. Despite the low-cost of such environmentally friendly renewable material, it could enhance the mechanical properties of construction materials. This project presents extensive experiments on the use of plant based natural fibers as reinforcement for cement-based composites, with a particular emphasis upon fiber types; fiber characteristic, and fiber-cement composites performance.
2	Solar PV pumps for sustainable irrigation in Egypt	This project represents a comprehensive design of photovoltaic water pumping system powered entirely by solar energy with object of conserving electricity by reducing the usage of grid power and conserving water by reducing water losses. The proposed system is easy to implement and environment friendly solution for irrigation fields as well as requires minimal maintenance and attention and is self-starting.



No	Project Name	Summary
3	Design and optimization of solar collectors' network for swimming pool heating application	<p>This project presents a general procedure for designing and optimizing the arrangement of solar collectors of swimming pool heating applications using TRNSYS software. The optimal arrangement of the solar collectors for thermal applications requires a merge between thermal and hydraulic objectives. For the thermal side, the working fluid must provide the heat load for the swimming pool at the specified temperature also for the hydraulic side the fluid must flow through the system facing a pressure drop within the specified limits. In this project, the overall arrangement of solar collectors which forms the total collector surface area is named by the (solar collector's network). This network will be practically applied on a swimming pool as a case study for this project. In addition to, an experimental model of a solar heater is constructed to fit the swimming pool.</p>
4	Design, Modeling, and performance analysis of solar still	<p>Two identical conventional solar still have been fabricated and will be assembled. For enhancing the freshwater yield, we used some parameters on solar still like black aluminum sheets fins fixed on a black basin (steel, 80*50*10 cm, thickness 6mm). The transparent glass covers 5 mm thickness were placed at an inclination of 30 degrees to the horizontal. Moreover, we used absorbing material like a black dye and sensible heat storage material on different water depth (20mm, 30mm and 40mm). Also, modeling has been carried out aided by some basic and simplified hypotheses, according to overall thermal energy balances on glass, water mass basin, while taking into consideration an atmospheric condition such as temperatures, humidity, and solar intensity as well as wind speed.</p>



No	Project Name	Summary
5	Smart campus	This project is still proceeding in the academic year 2020/2021 and it aims to construct a smart system for the life of students and staff members in university campus. It helps the education process and provides facilities to check attendance. It also allows students to enter the campus and study rooms with a smart card that can also be used for fees payment.

**Evidence url:**

<https://www.pua.edu.eg/pharos-university-organized-towards-sustainable-tomorrow-competition/>

**2) Lecture about Fuel Cells to the Petrochemical Engineering Department:**

Considering the significant development, the world has been witnessing recently in the development and production of hybrid and electric vehicles (HEV/EV) plus the recent developments in high voltage battery technologies due to its environmental advantages, the Petrochemical Engineering Department organized a lecture on fuel cells.



**Evidence url:**



<https://www.pua.edu.eg/%d9%85%d8%ad%d8%a7%d8%b6%d8%b1%d8%a9-%d8%b9%d9%86-%d8%ae%d9%84%d8%a7%d9%8a%d8%a7-%d8%a7%d9%84%d9%88%d9%82%d9%88%d8%af-%d9%84%d8%b7%d9%84%d8%a7%d8%a8-%d9%82%d8%b3%d9%85-%d9%87%d9%86%d8%af%d8%b3%d8%a9/>

### 3) A study aiming at designing a reactor to produce biofuel using hydrodynamic cavitation technique.

The Petrochemicals Department at the Faculty of Engineering carried out a study aiming at designing a reactor to produce biofuel using hydrodynamic cavitation technique. This technique is based on intensifying the rate of the reaction and the production of biofuels from non-edible oil by introducing bubbles to the liquid. A model was constructed to explain this process and validate it using experimental data. The reactor has already been implemented successfully and experiments have been conducted to test to prove its effectiveness. This clean biofuel is considered as an alternative to fossil fuel used in industry, in addition to avoiding the negative impacts of fossil fuel combustion.

NO.	DESCRIPTION	NO.	DESCRIPTION	NO.	DESCRIPTION
01	BIO FUEL	06	MECHANICAL STAINLESS STEEL SHAFT	11	TRANSPARENT STATOR
02	SEPARATION HOPPER	07	HIGH SPEED BEARING	12	8 Mm THREADED BOLT WITH NUTS
03	GLYCERIN	08	SAMPLING POINT	13	PERISTALTIC PUMP
04	ELECTRIC MOTOR (5000 RPM)	09	GATE VALVE (ISOLATION)	14	FLANGE
05	FLEXIBLE SHAFT COUPLING	10	CYLINDRICAL ABSORBER	15	MAGNETIC STIRRER

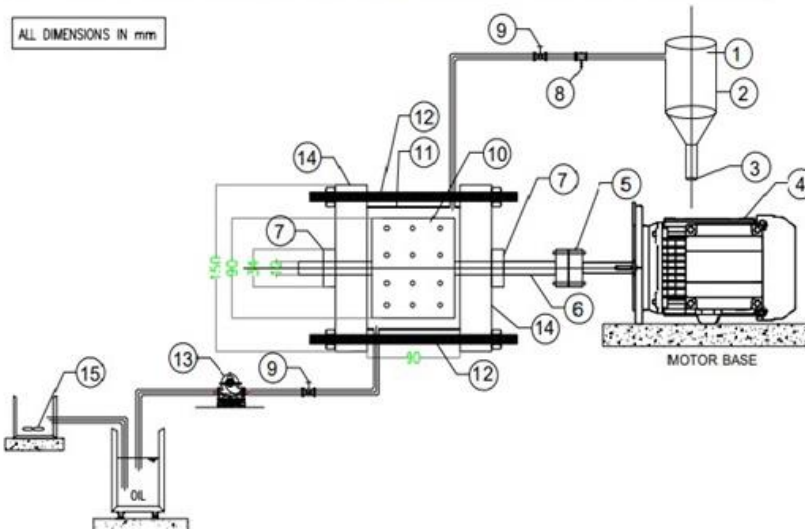

Evidence url:

<https://www.pua.edu.eg/production-of-biojet-fuel-using-hydrodynamic-cavitation-reactor-in-paros-university/>



#### 4) Mechanical Engineering Department visits Abu Qir Power Plant:

This is part of the Thermal Power Plants Operation & Management Course and the Control and Safety of Thermal Systems course for senior students in the Mechanical Power Engineering major. During the visit, the students learned about the different sections of the plant, namely: (steam and gas turbine room, filtration, purification and water treatment unit, boiler building, pumps room, automatic control, and monitoring room).



Evidence url:

<https://www.pua.edu.eg/mechanical-engineering-department-visits-abu-qir-power-plant/>

#### 5) Freshman students of the Basic Sciences Department and senior students of the Petrochemical Engineering Program visited Alexandria Specialty Petroleum Products Company (ASPPC).

The visit began with an introductory lecture on the history and establishment of the company. This was followed by a tour inside the production units and the different laboratories of the company, where the students were familiarized with the different control systems. The students expressed their delight with this visit and how they greatly benefited from it.





Evidence url:

<https://www.pua.edu.eg/faculty-of-engineerings-visit-to-asppc/>

6) The Electrical Engineering Department organized a scientific trip through visiting Sidi Kerir Power Plant of the West Delta Electricity Production Company (WDEPC).

The gas circuits (compressors, pistons, fire chambers, and gas turbines) and the steam cycle (gas turbines of various types, heat recovery boilers, and steam condensers) were examined. Many mechanical pumps, electric generators, primary and auxiliary transformers, excitation transformers, and all practical interconnecting circuits were also viewed on-site.

As a result, being familiarized with the complete work system through the main control center of the station, the students were given a realization of their role as the future engineer at the work site, whether as an operation engineer or a maintenance engineer.



Evidence url:

<https://www.pua.edu.eg/electrical-engineering-department-visits-sidi-kerir-power-plant/>



## 7) A field visit to the Sidi Kerir Petrochemicals Company (SIDPEC) for the students of the pre-engineering year.

Within the framework of the Faculty of Engineering's keenness on providing field visit to its students, the Basic Sciences Department, in cooperation with the Petrochemical Engineering Department, organized a field visit to the Sidi Kerir Petrochemicals Company (SIDPEC) for the students of the pre-engineering year.

The visit was welcomed by Eng. Mahmoud Basal, company's assistant president for production. The visit's program began with an introductory session about the company that included security and safety. Then the students listened to a detailed session about the production and manufacturing of polyethylene in the company. Later, the students visited the ethylene and the polyethylene plants.



Evidence url:

<https://www.pua.edu.eg/basic-sciences-and-petrochemical-engineering-departments-visit-sidpec/>





## 8) Protocol on Cooperation Between PUA and ANRPC:

A highly ranked delegation from Alexandria National Refine & Petrochemical Company (ANRPC) visited PUA on Wednesday, March 9th, 2022. The delegation was headed by Chem. Salah Gaber Bahnasy, Chairman and Managing Director. It also included Eng. Ghada Abdul Hameed, Technical Office



Director-General, Acc. Mohammad Ali Assi, Assistant Director for Financial Affairs, Chem. Essam Qabari, Director-General of Industrial Safety, Chem. Hany Mahmoud, Director-General of Operations, Mr. Abdul Latif Nazrah, Director-General of Public Relations. The delegation was welcomed in PUA's Council Hall in 3rd floor by Prof. Dr. Mahmoud Mohy El Din, PUA's President, Prof. Dr. Ramadan Abu El



Ella, Vice-President for Community Service and Environment Development, Prof. Dr. Abbas Anwar, Head of Petrochemical Engineering, Prof. Dr. Mohammad Yehia Al Mekki, Lecturer in the Faculty of Engineering, Chem. Hossam Anwar, Lecturer in Petrochemical Engineering Department, and Dr. Fathy Lecturer in Petrochemical Engineering Department.

Both parties discussed the possibilities of cooperation in the training field and participation in solving the technical issues, to which PUA can help find practical solution. Further, both parties agreed on the necessity of optimal utilization of the possibilities available to each respective party in conformity with the state's strategy in terms of connecting the industrial institutions with production sites, and the Egyptian scientific and academic institutions to achieve the developmental objectives of the Egyptian society. To this end, both parties agreed on a protocol on cooperation that was signed by Prof. Dr. Mahmoud





Mohy El-Din, as PUA President and Chem. Salah Gaber Bahnasy, as Chairman and Managing Director of ANRPC.

Evidence url:

<https://www.pua.edu.eg/protocol-on-cooperation-between-pua-and-anrpc/>

9) Pharos University has a protocol for cooperation in the field of renewable energy use with the New and Renewable Energy Development and Use Authority.

Evidence url:

[https://drive.google.com/file/d/1xxdDBbFjvPUzyYEd\\_OJfvQ-1jkNGKz3q/view](https://drive.google.com/file/d/1xxdDBbFjvPUzyYEd_OJfvQ-1jkNGKz3q/view)

10) Third International Conference on New Trends in Sustainable Energy (ICNTSE-2021):

PUA's Faculty of Engineering organizes the Third International Conference on New Trends in Sustainable Energy (ICNTSE-2021) on 1-2 March 2022 via online conference. It is also worth mentioning that the Journal of King Saud University – Engineering Sciences (JKSUES) will publish a special edition for a selected group of the conference's research, which meet the journal's publishing requirements.

<https://www.pua.edu.eg/faculty-of-engineering/conferences-2/icntse-2021/>

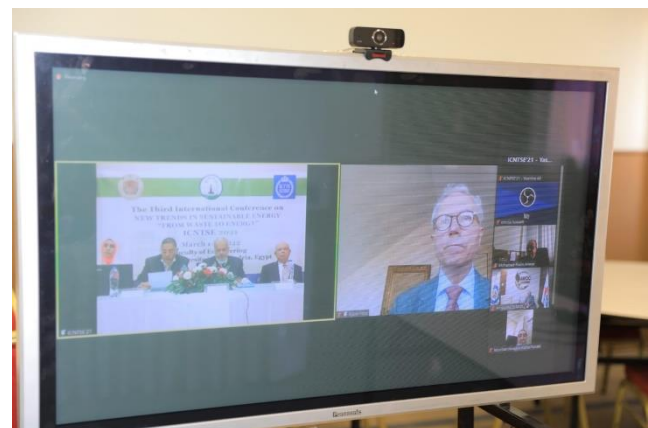

Evidence url:

<https://www.pua.edu.eg/third-international-conference-on-new-trends-in-sustainable-energy-icntse-2021-online/>



### 7.3 Courses in Curricula

No	Faculty in Pharos University	Course name	Course code	SDG of relevance	Topics in each course
1	Engineering	Energy Systems	EE 271	SDG 7	Studying the availability of using PV arrays in residential & commercial areas
2	Engineering	Energy conservation	EP 330	SDG 7	Different methods of energy conservation: electrical energy conservation, lightening, energy saving, heat energy saving, insulation, reusing of hot wastewater
3	Engineering	Renewable energy and storage systems	EM 333	SDG 7	Different methods of energy storage systems: electrical energy lightening, energy saving, heat energy saving, insulation, solar energy, smart building, equipment design, sensors and computer-controlled processes.



## 7.4 Publications

No	TITLE/YEAR/AUTHORS	DOI
1.	[HTML] Performance evaluation of continuous solar still water desalination system	10.1007/s10973-020-09547-5
2.	[HTML] Hybrid renewable energy/hybrid desalination potentials for remote areas: selected cases studied in Egypt	10.1039/d1ra00989c
3.	Novel sea water desalination unit utilizing solar energy heating system 2020 ElHelw, M.   El-Maghlany, W.M.   El-Ashmawy, W.M. Alexandria Engineering Journal	10.1016/j.aej.2020.03.019
4.	Enhanced solar desalination units 2020 Tayeb, A.M.   Farouq, R.   Shehata, A.Z.   Othman, R.H. Proceedings of Institution of Civil Engineers: Energy	10.1680/jener.19.00065



## SDG 8 – Decent Work and Economic Growth

### 8.1 – Research on Economic Growth and Employment

**8.1.1 Decent Work and Economic Growth:** (The proportion of a university's publications appear in the top 10% of journals. It is intended to reflect on excellence of academic output.)

Pharos University researchers published 54 papers in the top 10% of journals (CiteScore).

### 8.2 – Employment Practice

**8.2.1 Employment practice living wage** (Pay all staff and faculty at least the living wage)

PUA pays all staff and faculty at least the living wage.

Evidence url:

<https://www.pua.edu.eg/wp-content/uploads/2020/11/adjusted-Core-Values.pdf>

Evidence url:

<https://www.pua.edu.eg/wp-content/uploads/2019/12/Policy-Statements-2018.pdf>

**8.2.2 Employment practice unions** (Recognize unions and labor rights (freedom of association and collective bargaining) for all)

PUA recognize unions & labor rights (freedom of association & collective bargaining) for all, including women & international staff.

Evidence url:

<https://www.pua.edu.eg/wp-content/uploads/2020/11/adjusted-Core-Values.pdf>

Evidence url:

<https://www.pua.edu.eg/wp-content/uploads/2019/12/Policy-Statements-2018.pdf>



### 8.2.3 Employment policy on discrimination (Have a policy on ending discrimination in the workplace)

PUA have a policy on ending discrimination in the workplace.

Evidence url:

<https://www.pua.edu.eg/wp-content/uploads/2020/11/adjusted-Core-Values.pdf>

Evidence url:

<https://www.pua.edu.eg/wp-content/uploads/2019/12/Policy-Statements-2018.pdf>

In addition, PUA's employment opportunity advertisement shows no bias or discrimination actions.

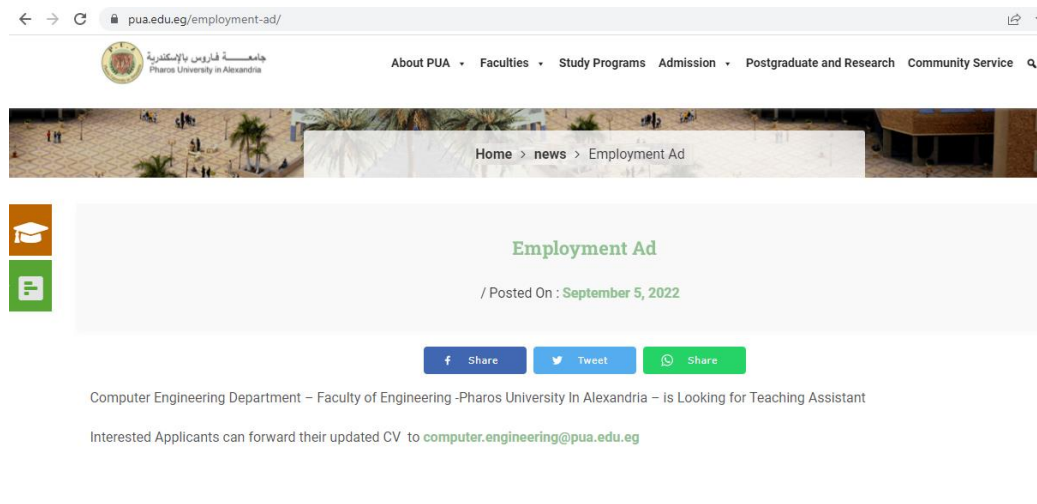

Evidence url:

<https://www.pua.edu.eg/employment-ad/>





Home > news > ACADEMIC JOB ANNOUNCEMENT

### ACADEMIC JOB ANNOUNCEMENT

/ Posted On : September 1, 2022

Pharos University in Alexandria announces its desire to appoint a **number of Staff Members (Professor – Assistant Professor)** for the academic year 2022-2023, through appointment or secondment. Applicants must hold a doctorate degree obtained from one of the Egyptian universities or equivalent degrees in the same discipline.

Vacancies are available in the following Faculties and disciplines: –

- Faculty of Engineering
- Electronics and Communications Engineering
- Electric Power Engineering

Applicants are kindly requested to send their CVs via e-mail to [hr.acad@pua.edu.eg](mailto:hr.acad@pua.edu.eg), with their names, faculty and discipline being applied to in the email subject.

Evidence url:

<https://www.pua.edu.eg/academic-job-announcement/>

Furthermore, PUA supports all efforts and initiatives against discrimination, for example:

A graduation project 2020/2021 titled: Your word makes a difference | A campaign against bullying, produced by students of the Public Relations Department at the Faculty of Mass Communication, Pharos University.



**Your word makes a difference | A campaign against bullying, produced by students of the Public Relations Department at the Faculty of Mass Communication, Pharos University**

Evidence url:



<https://www.pua.edu.eg/faculty-of-mass-communication/graduation-projects-for-the-academic-year-2020-2021/>

#### 8.2.4 Employment policy modern slavery (Have a policy commitment against forced labor, modern slavery, human trafficking, and child labor)

PUA have a policy commitment against forced labor, modern slavery, human trafficking, and child labor.

**Evidence url:**

<https://www.pua.edu.eg/wp-content/uploads/2019/12/Policy-Statements-2018.pdf>

In addition, as part of the University's concern for the health and safety, the University initiated an online excuses system regarding the procedures for medical excuses Corona and the mechanism of medical procedures for staff and students (in case of infection with the Corona virus).

**Evidence url:**

<https://www.pua.edu.eg/%d8%a7%d8%b9%d9%84%d8%a7%d9%86-%d9%87%d8%a7%d9%85-%d8%a8%d8%ae%d8%b5%d9%88%d8%b5-%d8%a7%d8%ac%d8%b1%d8%a7%d8%a1%d8%a7%d8%aa-%d8%a7%d9%84%d8%a7%d8%b9%d8%b0%d8%a7%d8%b1-%d8%a7%d9%84%d8%b7%d8%a8%d9%8a/>

#### 8.2.5 Employment practice equivalent rights outsourcing (Have a policy on guaranteeing equivalent rights of workers when outsourcing activities to third parties)

PUA have a policy on guaranteeing equivalent rights of workers when outsourcing activities to third parties.

**Evidence url:**

<https://www.pua.edu.eg/wp-content/uploads/2019/12/Policy-Statements-2018.pdf>

#### 8.2.6 Employment policy pay scale equity (Have a policy on pay scale equity including a commitment to measurement and elimination of gender pay gaps)

**Evidence url:**

<https://www.pua.edu.eg/wp-content/uploads/2019/12/Policy-Statements-2018.pdf>



### 8.2.7 Tracking pay scale for gender equity (Measurement or tracking pay scale gender equity)

PUA have a policy on pay scale equity including a commitment to measurement and elimination of gender pay gaps.

Evidence url:

<https://www.pua.edu.eg/wp-content/uploads/2019/12/Policy-Statements-2018.pdf>

<https://www.pua.edu.eg/wp-content/uploads/2022/11/SDG-5-Report-Final.pdf>

### 8.2.8 Employment practice appeal process (Have a process for employees to appeal on employee rights and/or pay)

PUA have a process for employees to appeal on employee rights and/or pay. In addition, there is a special section at the administration department for appeals of all types.

Evidence url:

<https://www.pua.edu.eg/wp-content/uploads/2020/11/adjusted-Core-Values.pdf>

## 8.3 – Employees

- the actual number of employees: 1122

## 8.4 – Proportion of students taking work placements

### 8.4.1 Indicator: Proportion of students with placements

- the number of students in all years and of all programs: 11582
- the number of students with work placements (required as part of the course) of more than a month: 8921

PUA pays a lot of attention to the quality of its graduates. Therefore, PUA is keen to secure distinguished training opportunities for students. One of its endeavors to do so is organizing regular job and training fairs, inviting reputable industry organizations to select and hire trainees from all faculties and disciplines.



### 5th Job Fair

/ Posted On : July 19, 2022

Prof. Dr. Mahmoud Mohy El-din, PUA's President, launched the Fifth job fair, which was organized by the Faculty of Tourism and Hotel Management.

This fair comes within PUA's endeavor to provide job opportunities for its graduates, and to implement training partnerships with various tourism companies and hotel chains in Alexandria.

The fair witnessed a large presence of industry men and Faculty's cooperation partners, represented by 20 tourism companies and hotels. As well as representatives of the Ministry of Tourism and the Tourism Promotion Authority in Alexandria.

Accordingly, the Faculty administration extends its sincere thanks and appreciation to all those who thankfully participated in the job fair. As well as for the support provided to promote the level of training in the Faculty, and facilitating the graduates' access to proper job opportunities.



### Evidence url:

<https://www.pua.edu.eg/5th-job-fair/>

In addition, various partnerships and agreements with industry organizations are in place to increase the training and employment opportunities for our students and graduates.



### Protocol on Cooperation Between PUA and Alexandria Mineral Oils Company (AMOC)

/ Posted On : February 13, 2022

A prestigious delegation from Alexandria Mineral Oils Company (AMOC) headed by Chem. Ehab Ahmed Abdul Halim, Chairman and Managing Director, visited PUA on early Monday 07/02/2022. It included Mrs. Hala Wagih, Assistant Director for Training and Human Resources Development, Mrs. Rania Al Maleki, Director-General for Media and External Affairs, Eng. Mohammad Abdul Razaq, Director-General of the Public Administration for Chemical Labs, along with other leading staff members. The delegation was welcomed in PUA's Grand Hall by Prof. Dr. Ramadan Abu Al Ella, Vice-president for Community Services and Environment Development, Prof. Dr. Mohamed Gaber Abou Ali, Dean of the Faculty of Engineering, Prof. Dr. Gamal Behiry, Dean of the Faculty of Computer Science and Artificial Intelligence, Prof. Dr. Mohammad Yahia Al Mekki, Faculty of Engineering, as well as other faculty members of the Faculty of Engineering.

Both Parties have tackled the prospects of mutual cooperation in training fields, and participation in solving the technical issues, to which PUA can contribute in finding practical solutions. Accordingly, both parties have agreed on making optimal use of their respective capabilities in a manner compliant with the state's strategy in terms of connecting industrial institutions and productions sites, with the Egyptian Scientific and Academic Institutions to achieve the developmental objectives of the Egyptian society. To achieve that, a protocol on cooperation has been signed by Prof. Dr. Ramadan Abu Al Ella, as PUA's Vice-president for Community Services and Environment Development and Chem. Ehab Ahmed Abdul Halim, as Chairman and Managing Director of Alexandria Mineral Oils Company (AMOC).



### Evidence url:

<https://www.pua.edu.eg/protocol-on-cooperation-between-pua-and-alexandria-mineral-oils-company-amoc/>



## 8.5 – Proportion of employees on secure contracts

### 8.5.1 Indicator: Proportion of employees on secure contracts

- the (Full Time Equivalent) number of employees: 1122
- the (Full Time Equivalent) number of employees on contracts of over 24 months: 1098.





## 8.6 – Courses in Curricula

In addition to the above-mentioned activities to achieve decent work and economic growth, PUA is paying a lot of attention to this point, and that can be seen in the following activities:

The courses in the table below address the topic of economic growth. These courses are 7 courses, and are delivered for undergraduates in 4 faculties:

No	Faculty in Pharos University	Course name	Course code	SDG of relevance	Topics in each course
1	Applied Health Sciences Technology	Lab Management	MLLM-101	SDG 8	Green procedures and procurements
2	Tourism	Human Resource Management	THM 261	SDG 8	Economic growth and enterprises
3	Tourism	Industry Internship (1), (2), (3) and (4)	HM 391, HM392, HM 493, and HM 494	SDG 8	Economic growth and partnership with tourism companies
4	Mass communication	Electronic marketing	PRAD (205)	SDG 8	Introducing the concept of e-marketing, market definition and division, marketing environment, and how to identify and study consumer
5	Business	International Economics	BF 636	SDG 8	The course focuses on international economic relations and its sustainability
6	Business	Corporate Finance	BF533	SDG 8	The course introduces the sustainable finance systems in corporates for entrepreneurs.
7	Business	Entrepreneurship	BT 637	SDG 8	Think tank and incubators



## 8.7 – Decent Work and Economic Growth: Publications

8.7.1 Decent Work and Economic Growth: Publications: (The number of publications looks at the scale of research output from a university around decent work and economic growth.)

Pharos University researchers published 8 papers on Decent Work and Economic Growth.

No.	TITLE/YEAR/AUTHORS	DOI
1	A flexible ergonomic redesign of the sewing machine workstation 2020 Research Journal of Textile and Apparel	10.1108/RJTA-10-2019-0050
	Eladly, A.M.   Abou-Ali, M.G.   Sheta, A.M.   EL-Ghlomy, S.H.	
	Alexandria University	
2	Smart and Incremental Model to Build Clustered Trending Topics of Web Documents 2020 Advances in Intelligent Systems and Computing	10.1007/978-3-030-14118-9_87
	Abou-Of, M.A.   Saad, H.M.   Darwish, S.M.	
	Alexandria University	
3	Posture deviation of head and neck in heavily using smart phone adolescents: An observational cross sectional study 2020 Fizjoterapia Polska	-
	Wahba, A.Y.E.   Abdelazeem, F.H.   Elshafey, M.A.M.	
	Cairo University	



No.	TITLE/YEAR/AUTHORS	DOI
4	Predicting Stock Market Trends for Japanese Candlestick Using Cloud Model 2020 Advances in Intelligent Systems and Computing	10.1007/978-3-030-44289-7_59
	Madbouly, M.M.   Elkholy, M.   Gharib, Y.M.   Darwish, S.M.	
	Alexandria University	
5	Effect of stretching exercises in treatment of muscle strain: A systematic review 2020 Fizjoterapia Polska	-
	Hassan, K.A.   Abdelrahman, M.A.   Fayaz, N.A.   Abdelkader, N.A.	
	Cairo University	
6	Sustainable Touristic path toward cultural identity 2020 Journal of Engineering Research	10.21608/erj.2020.145854
	Ragheb, R.A.   Naguib, I.M.	
	Pharos University in Alexandria	
7	Efficacy of Kinesio Taping and Postural Correction Exercises on Levator Scapula Electromyographic Activities in Mechanical Cervical Dysfunction: A Randomized Blinded Clinical Trial 2020 Journal of Manipulative and Physiological Therapeutics	10.1016/j.jmpt.2019.05.010
	Elabd, A.M.   Ibrahim, A.R.   Elhafez, H.M.   Hussien, H.A.   Elabd, O.M.	
	Delta University for Science and Technology   Umm Al-Qura University   Cairo University	
8	Investigating the status of egyptian entrepreneurship in an era of revolution and reforms 2020 Proceedings of the European Conference on Innovation and Entrepreneurship, ECIE	10.34190/EIE.20.002
	Ragab, Y.   Ragab, M.   Monaghan, S.	
	Trinity College Dublin	



## SDG 9 – Industry Innovation and Infrastructure

### 9.1 – Industry, Innovation, and Infrastructure Events

#### Protocol on Cooperation Between PUA and ANRPC

<https://www.pua.edu.eg/protocol-on-cooperation-between-pua-and-anrpc/>

Highly ranked delegation from Alexandria National Refine & Petrochemical Company (ANRPC) visited PUA on Wednesday, March 9th, 2022. The delegation was headed by Chem. Salah Gaber Bahnasy, Chairman and Managing Director. It also included Eng. Ghada Abdul Hameed, Technical Office Director-General, Acc. Mohammad Ali Assi, Assistant Director for Financial Affairs, Chem. Essam Qabari, Director-General of Industrial Safety, Chem. Hany Mahmoud, Director-General of Operations, Mr. Abdul Latif Nazrah, Director-General of Public Relations. The delegation was welcomed in PUA's Council Hall in 3rd floor by Prof. Dr. Mahmoud Mohy El Din, PUA's President, Prof. Dr. Ramadan Abu El Ella, Vice-President for Community Service and Environment Development, Prof. Dr. Abbas Anwar, Head of Petrochemical Engineering, Prof. Dr. Mohammad Yehia Al Mekki, Lecturer in the Faculty of Engineering, Chem. Hossam Anwar, Lecturer in Petrochemical Engineering Department, and Dr. Fathy Lecturer in Petrochemical Engineering Department.

Both parties discussed the possibilities of cooperation in the training field and participation in solving the technical issues, to which PUA can help find practical solution. Further, both parties agreed on the necessity of optimal utilization of the possibilities available to each respective party in conformity with the state's strategy in terms of connecting the industrial institutions with production sites, and the Egyptian scientific and academic institutions to achieve the developmental objectives of the Egyptian society. To this end, both parties agreed on a protocol on cooperation that was signed by Prof. Dr. Mahmoud Mohy El-Din, as PUA President and Chem. Salah Gaber Bahnasy, as Chairman and Managing Director of ANRPC.



## Faculty of Engineering Organizes a Workshop: Industry 4.0 and Digital Twinning in Effective Teaching

<https://www.pua.edu.eg/faculty-of-engineering-organizes-a-workshop-industry-4-0-and-digital-twinning-in-effective-teaching/>

Due to the implications of industry 4.0, major changes occurred to the businesses that strongly affected manufacturing processes and competitive features of local and international companies, industries, and systems.

In this regard, Faculty of Engineering, PUA organized a workshop that aims at contributing in the discussion on the effect of Industry 4.0 through surveying academic and industrial viewpoints. This can be done through the application of the technologies of the 21st century Industry 4.0. These technologies include Smart Manufacturing, Industrial Internet of Things, PC-based Controls, Autonomous Things (AuT), AR/VR, Artificial Things, which are considered the core of Industry 4.0.







## PUA's Faculty of Engineering Sign a Cooperation Protocol with TÜV AUSTRIA

<https://www.pua.edu.eg/puas-faculty-of-engineering-sign-a-cooperation-protocol-with-tuv-austria/>

In the context of supporting the academic study of the faculty students, providing them with practical and field experiences, and linking the curricula with industrial fields to achieve the sought integration, Prof. Dr. Mohamed Gaber Abou Ali, Dean of the Faculty of Engineering along with a group of the faculty professors welcomed Mr. Osama El-Sayed Ibrahim, Regional Director of TÜV AUSTRIA, on Wednesday, January 26, 2022. The meeting included the signing of a cooperation protocol between PUA's Faculty of Engineering and TÜV Austria.

In addition, during this meeting, aspects of cooperation between the two parties were tackled. These aspects included providing training opportunities and specialized workshops for the faculty students, providing experienced staff to supervise the students' research and projects at the faculty, which would provide solutions to some of the industry's problems. In a similar context, the faculty organizes training programs, workshops, conferences, and seminars for the company's employees. It also provides academic consultations considering the experience of its professors to solve some of the company's problems, which requires conducting research and studies in this regard.





## PUA Signs a Protocol on Cooperation with Alexandria Specialty Petroleum Products Company (ASPPC)

<https://www.pua.edu.eg/pua-signs-a-protocol-on-cooperation-with-alexandria-specialty-petroleum-products-company-asppc/>

On Early Tuesday, 22 Feb 2022, a high-ranking delegation of Alexandria Specialty Petroleum Products Company (ASPPC) visited PUA. The delegation was headed by Chem. Dr. Mosaad Attia Al Qasabi, Chairman and Managing Director. The delegation also included Eng. Eid Qassim, Assistant Director of Production, Eng. Ayman Hegazi, Assistant Director of Technical Affairs, Dr. Tariq Abbas, Assistant Director of Marketing, Acc. Ez Abdul Salam, Director-General of Supplies, Dr. Bassim Abdullah, Director-General of Technology and Development.



The delegation was hosted in PUA's Grand Hall by Prof. Dr. Mahmoud Mohy El-Din, President, Prof. Ramadan Abu El-Ala, Vice



President of Community Service & Environment Development Affairs, Prof. Dr. Prof. Mohamed Gaber Abou Ali, Dean of the Faculty of Engineering, Prof. Dr. Gamal Elbhery, Dean of the Faculty of Computer Science & Artificial Intelligence, Prof. Dr. Mohamed Yahia Al Mekki, Professor of Engineering, and several faculty members of the Faculty of Engineering.

Both parties discussed mutual cooperation possibilities in training fields, and participating in solving the technical issues, to which PUA can contribute in finding practical solutions. Thus, the parties agreed on the necessity of the optimal use of each party's available capabilities in a manner compliant with the state's strategy in terms of connecting the industrial institutions with production



sites, and the Egyptian scientific and academic institutions to achieve the developmental objectives of the Egyptian society. To this end, both parties agreed on a protocol on cooperation that was signed by Prof. Dr. Mahmoud Mohy El-Din, as PUA President and Chem. Dr. Mosaad Attia Al Qasabi, as Chairman and Managing Director of Alexandria Specialty Petroleum Products Company (ASPPC).



### Protocol on Cooperation Between PUA and Alexandria Mineral Oils Company (AMOC)

<https://www.pua.edu.eg/protocol-on-cooperation-between-pua-and-alexandria-mineral-oils-company-amoc/>

A prestigious delegation from Alexandria Mineral Oils Company (AMOC) headed by Chem. Ehab Ahmed Abdul Halim, Chairman and Managing Director, visited PUA on early Monday 07/02/2022. It included Mrs. Hala Wagih, Assistant Director for Training and Human Resources Development, Mrs. Rania Al Maleki, Director-General for Media and External Affairs, Eng. Mohammad Abdul Razaq, Director-General of the Public Administration for Chemical Labs, along with other leading staff members. The delegation was welcomed in PUA's Grand Hall by Prof. Dr. Ramadan Abu Al Ella, Vice-president for Community Services and Environment Development, Prof. Dr. Mohamed Gaber Abou Ali, Dean of the Faculty of Engineering, Prof. Dr. Gamal Behiry, Dean of the Faculty of Computer Science and Artificial Intelligence, Prof. Dr. Mohammad Yahia Al Mekki, Faculty of Engineering, as well as other faculty members of the Faculty of Engineering.

Both Parties have tackled the prospects of mutual cooperation in training fields, and participation in solving the technical issues, to which PUA can contribute in finding practical solutions. Accordingly, both parties have agreed on making optimal use of their respective capabilities in a manner compliant with the state's strategy in terms of connecting industrial institutions and productions sites, with the Egyptian Scientific and Academic Institutions to achieve the developmental objectives of the Egyptian society. To achieve that, a protocol on cooperation has been signed by Prof. Dr. Ramadan Abu Al Ella, as PUA's Vice-president for Community Services and Environment Development and Chem. Ehab Ahmed





Abdul Halim, as Chairman and Managing Director of Alexandria Mineral Oils Company (AMOC).





## Cooperation Protocol between Pharos University and Arab Organization for Industrialization

<https://www.pua.edu.eg/cooperation-protocol-between-pharos-university-and-arab-organization-for-industrialization/>



A high-level delegation from the Arab Organization for Industrialization visited Pharos University (P.U.A), and the delegation was headed by Major General /Ahmed Abdel Aziz – chairman of the board of directors of the electronics factory in the organization. The delegation included Dr. Essam Mansour – Advisor to the



chairman of the board of directors of the electronics factory and Eng. Ashraf Khalil – head of the Human Resources sector. The two parties discussed the possibilities of cooperation in the fields of scientific research, training, and participation in solving technical problems for the sake of carrying out research and patents and benefiting from the scientific and human capabilities at Pharos university and the Arab Organization for Industrialization. The delegation was





received by Prof. / Mahmoud Mohy Al-Din – President of the University, Prof. / Ramadan Abu Al-Ela – Vice President for Community Service and Environmental Development Affairs, Prof. / Mohammed Gabar Abu Ali Faculty of Engineering Dean, Prof. / Mohammed Naem Faculty of Engineering Vice Dean, and Prof./ Mohammed Yahia Al-Makki Professor at the Faculty of Engineering, and several teaching staff committees at the faculty. Both parties agreed on the optimal use of the resources to move to the rank of developed countries and achieving the developmental desired aims of the Egyptian society and to accomplish the above the both parties signed a cooperation protocol signed by Prof./ Mahmoud Mohy El-Din as a Pharos University President Also Major General/ Ahmed Abdel Aziz – authorized by Lieutenant General chairman of the organization

### **Cooperation Protocol between Pharos University and Electronic Researches Institute**

<https://www.pua.edu.eg/cooperation-protocol-between-pharos-university-and-electronic-researches-institute/>

Implementing to what agreed on between Pharos University and Electronic Researches Institute during a visit of delegation headed by Dr./ Shereen Abd Al-Qadar – in charge of institute president to Pharos university and that on Wednesday 17/11/2021, and high delegation from Pharos university headed by Dr./ Ramadan Abo Al-Alaa University Vice President for Society Service Affairs visited the institute on Tuesday 14/12/2021. And the delegation included: Prof./ Mohammed Gabar – Engineering Faculty Dean and Prof./ Mohammed Naem – Vice Dean of Engineering faculty- Prof./ Mohammed Abd Al-Rahman – Electric Engineering head of department and Dr./ Nabil Rashwan teacher at Electronic Engineering department. And the delegation was received by Dr./ Shereen Abd Al-Qadar – in charge of institute president and the visit was done by: Dr. Ahmed Attia – in charge of Microwave Engineering head of department and Dr./ Magad Naqib –High Energy head of department and Dr./ Ghada Farouq – In charge of information research head of department, and Dr./ Haitham Husien Abd Alluah Professor at microwave department and Eng./ Sameer Husien head of central laboratories at the institute. And the university delegation inspected the central laboratories and the specialized laboratories (Nano Technology, Precise Electronics, photonic cells and high energy) as well the building of the emerging companies and business leading building, the both parties agreed on that the cooperation will be on different axes including student training in the institute laboratory and supervision and following up the graduation projects. Also, the business leading technological incubators in the electronic and communication



field and information technology to expand the cooperation foundation in the industry and implement projects and researches to serve the community.





## Pharos University to Foster Ties with the Industrial Modernization Centre

<https://www.pua.edu.eg/pharos-university-to-foster-ties-with-the-industrial-modernization-centre/>



Prof. Ramadan Abu El-Ala, the Vice President of Community Service and Environment Development Affairs, along with Prof. Hana Yassin, the Dean of the Faculty of Arts and Design- Pharos University held a meeting with some representatives of both branches of the Industrial Modernization Centre (IMC) in Cairo and Alexandria and the Coordinator of the Innovation Programs in Nile

University and NilePreneurs Initiative. The distinguished guests included the following:

1. Hisham Mohamed Sayed Basha, the Deputy Director of the Industrial Modernization Centre (IMC)
2. Ahmed Hossam El Din, an expert in business development
3. Ibrahim Atashy Ibrahim, the Head of the Industrial Modernization Centre (IMC) in Borg Al Arab – Alexandria
4. Mohamed Abbas Gomaa, the Coordinator of the Innovation and Technological Incubators Program.



This was held in the presence of Dr. Shaimaa Khodair, the Head of the Training Unit at the faculty of Arts and Design. During the meeting, means of cooperation were sought between Pharos University on one side and the Industrial Modernization Centre (IMC) and the whole industrial sector in Alexandria on the other side, in concern with the realm of field training as well as the implementation of the students' graduation projects. It was also discussed the possibility of the participation of Pharos University in providing solutions to some of the problems encountered by the industrial sector in Alexandria. At the end of the meeting, Prof. Ramadan Abo El-Ala called for another meeting between Pharos University and the Industrial Modernization Centre (IMC) to work on achieving the goals of the community service sector in Pharos University and finding solutions for the problems of the industrial sector in Alexandria.



## 9.2 – Publications

No.	TITLE/YEAR/AUTHORS	DOI
1	Investigation of physical, mechanical and gamma-ray shielding properties using ceramic tiles incorporated with powdered lead oxide 2020 Ceramics International	10.1016/j.ceramint.2020.03.119
	Mahmoud, M.E.   El-Khatib, A.M.   Halbas, A.M.   El-Sharkawy, R.M.	
	Pharos University in Alexandria   Alexandria University	
2	Oil spill clean-up using combined sorbents: a comparative investigation and design aspects 2020 International Journal of Environmental Analytical Chemistry	10.1080/03067319.2019.1636976
	Tayeb, A.M.   Farouq, R.   Mohamed, O.A.   Tony, M.A.	
	Menoufia University   Pharos University in Alexandria   Minia University   Port Said University	
3	Towards a secure signature scheme based on multimodal biometric technology: Application for iot blockchain network 2020 Symmetry	10.3390/sym12101699
	Hassen, O.A.   Abdulhussein, A.A.   Darwish, S.M.   Othman, Z.A.   Tiun, S.   Lotfy, Y.A.	
	Universiti Kebangsaan Malaysia   Pharos University in Alexandria   Alexandria University   Ministry of Education, Iraq	
4	Functionalization of CeO <sub>2</sub> -SiO <sub>2</sub> -(CH <sub>2</sub> ) <sub>3</sub> -Cl nanoparticles with sodium alginate for enhanced and effective Cd <sup>II</sup> , Pb <sup>II</sup> , and Zn <sup>II</sup> ions removal by microwave irradiation and adsorption technique 2020 Environmental Nanotechnology, Monitoring and Management	10.1016/j.enmm.2020.100367
	El-Sharkawy, R.M.   Allam, E.A.   Mahmoud, M.E.	
	Pharos University in Alexandria   Alexandria University	
5	Applicability of Using Natural Fibers for Reinforcing Concrete 2020 IOP Conference Series: Materials Science and Engineering	10.1088/1757-899X/809/1/012018
	El-Nadoury, W.W.	
	Pharos University in Alexandria	



No.	TITLE/YEAR/AUTHORS	DOI
6	Nano-manganese oxide-functionalized-oleyl amine as a simple and low cost nanosorbent for remediation of ZnII/CoII and their radioactive nuclides 65Zn and 60Co from water 2020 Applied Radiation and Isotopes	10.1016/j.apradiso.2019.108989
	Mahmoud, M.E.   Allam, E.A.   El-Sharkawy, R.M.   Soliman, M.A.   Saad, E.A.   El-Khatib, A.M.	
	Ain Shams University   Pharos University in Alexandria   Egyptian Atomic Energy Authority   Alexandria University	
7	Validated specific HPLC-DAD method for simultaneous estimation of paracetamol and chlorzoxazone in the presence of five of their degradation products and toxic impurities 2020 Drug Development and Industrial Pharmacy	10.1080/03639045.2020.1821054
	El-Yazbi, A.F.   Guirguis, K.M.   Bedair, M.M.   Belal, T.S.	
	Pharos University in Alexandria   Alexandria University	
8	Optimization of photocatalytic degradation of methylene blue dye using titanate nanotube 2020 Journal of Nanophotonics	10.1117/1.JNP.14.026008
	Tayeb, A.M.   Hussein, D.S.   Farouq, R.	
	Pharos University in Alexandria   Minia University	
9	A flexible ergonomic redesign of the sewing machine workstation 2020 Research Journal of Textile and Apparel	10.1108/RJTA-10-2019-0050
	Eladly, A.M.   Abou-Ali, M.G.   Sheta, A.M.   EL-Ghlomy, S.H.	
	Pharos University in Alexandria   Alexandria University	
10	Business trends: Application of blockchain technology in the petrochemical industry 2020 Hydrocarbon Processing	-
	Ezzat, A.A.	
	Pharos University in Alexandria	
11	H-Seed: Vision for smart city 2020 WIT Transactions on Ecology and the Environment	10.2495/SDP200091
	Shehata, H.M.   Bakr, A.F.   Hassan, A.	
	Pharos University in Alexandria   Alexandria University	





### 9.3 – Courses in Curricula

No	Faculty in Pharos University	Course name	Course code	SDG of relevance	Topics in each course
1	Pharmacy	Good Manufacturing Practices	PPC E02	SDG 9	Responsible production consumption techniques in pharmaceutical industry
2	Tourism	Entrepreneurship in Hospitality Industry (Elective)		SDG 9	Economic growth and partnership with tourism companies



## SDG 10 – Reduced Inequalities

### 10.1 – Scholarships to Support Students in Need

In congruence with this goal, Pharos University supported some students in-need with full scholarships, and others with waiving students fees up to 50% depending on social assessments <https://www.pua.edu.eg/pua-admission/scholarships-and-tuition-waivers/> and <https://www.pua.edu.eg/pua-admission/tuition-fees/>.

In the academic year 2021-2022, there were 32 scholarships and tuition fees waiving (Table 1) to both males and female students in almost all faculties.

According to private and confidential social assessments carried out for each student, the amount of waiving of fees is determined that ranged between 10% to 50%.

Table 1. Number of students in need that are supported by Pharos University in the Academic year 2021-2022

Faculty	Male	Female	Total
Pharmacy and Drug Manufacturing	5	3	8
Dentistry	6	2	8
Engineering	4	2	6
Financial and Administrative Sciences			0
Languages and Translation			0
Legal Studies			0
Tourism and Hotel Management			0
Physical Therapy	3	7	10
Mass Communication			0
Applied Health Sciences Technology			0
Arts and Design			0
Total	18	14	32



Table 2. Number of students with disabilities that are supported by Pharos University in the Academic year 2021-2022

	Male	Female	Total
Pharmacy and Drug Manufacturing			0
Dentistry			0
Engineering	18	4	22
Financial and Administrative Sciences			0
Languages and Translation	1	5	6
Legal Studies	5	1	6
Tourism and Hotel Management	3	1	4
Physical Therapy	2	4	6
Mass Communication	7	4	11
Applied Health Sciences Technology	2	0	2
Arts and Design	4	7	11
Total	42	26	68

## 10.2 – Reduced Inequalities Activities

### 1. Orphans' day celebration

The students and faculty members of PUA celebrated Orphans Day. The coordination was made between the Community Services and Environment Development Affairs and six charities. The ceremony was held at those charities. On 9th and 10th of April 2021, PUA formed six groups comprised of students, faculty members and coordinators of the student activities to visit those charities and give the orphans toys, gifts and clothes that had a good impact on children and staff. It is worth mentioning that the students were excited and happy for participating in this charity work. The visits were divided as following:



On Friday, 9 April 2021:

“Tarek ElKhair” Community Service, Sidi Gaber.

“Al mutadarieun” Community Service, Rabaa El Nasria, Abis.

“El Qalaa” Community Service, Awayed.

“Kfalet El Yatem” Community Service, Ezbet Fathi.

On Saturday, 10 April 2021:

“Nabaa El Hop” Community Service, El Hadra El Gadida.

“El Estqrar” Community Service, Zawya Abd El-Qader, Al Amaria.

[Pharos University Celebrated Orphans Day](#)



## 2. Qawafel Al Khair Drive of PUA

In continuation of the annual tradition accustomed by Pharos University management and implemented and followed-up by the Board of Trustees headed by Eng. Alaa Ragab, Chairman of the Board of Trustees, 7 charitable



convoys (Qawafel Al Khair) were dispatched to several areas in Alexandria. The convoys included student activities supervisors, some faculty members, and many students, who participated in this charitable work with great enthusiasm. In addition to the participation and supervision of Prof. Dr. Ramadan Abu El-Ala, Vice President of the University for Community Service and Environmental Development. The convoys covered the areas of Bahri, Souk al-Turk (Ras Al Tin Society), Abis (Al Mutadaroon Society) and (Mujib al-Sayyelin Society), Al Hadra Al Gadida, Zohour Street (Naba'a Al Hob Society), Sidi Gaber (Tariq Al Khair Society), Al Awayed (Al-Qalaa Society), and Al-Amiriya (Al Istikrar Society). This activity comes within the framework of the administration's keenness to implement its role in developing the students' spiritual and moral values. In addition to promoting the value of loyalty, sense of belonging, and societal involvement, which all were clearly reflected through the students' enthusiasm to participate, and their happiness in performing these charitable works.

### [Qawafel Al Khair Drive of of PUA](#)

## 3. Faculty of Legal Studies' Charity Market

As part of the student activities, the Faculty of Legal Studies organized a charity market to distribute Ramadan supplies to the workers free of charge. The market that took place on Wednesday, April 20, 2022, was opened by Prof. Dr. Ramadan Abu El Ala, Vice President for Community Service and Environmental Development, and Prof. Dr. Hammam Zahran, Dean of the Faculty of Legal Studies. Further,







it was attended by a group of faculty members and teaching assistants, along with a large number of students.

#### [Faculty of Legal Studies' Charity Market](#)

#### **4. A field visit to the association of “Donitna” for blinds for redeveloping handicrafts**

Under the student activities program of the faculty of arts and design, a field visit was coordinated to redevelop the handicrafts of Donitna association for blinds. It aims to provide students with information about welfare and social development organization in terms of its objectives and all the services it provides, and to make students aware of the need for active participation in the most basic tools that can be effective to add a lot needs of others and to fill the disability of those unable in society.

It was on Saturday 9-10-2021 in the special care home for blind persons where they were directed to teach them bamboo handicrafts and handmadecarpets. After students learned and discussed how to develop products, some products were selected with appropriate designs and implementation using acrylic colours. Students added different artistic and aesthetic touches to the products which was well received by the community and the day ended with students feeling happy

<https://www.pua.edu.eg/a-field-visit-to-the-association-of-donitna-for-blinds-for-redeveloping-handicrafts/>





## 5. Sports Activities and Courses for females

As part of its interest in organizing sports activities and courses, the Student Activities Department organized several programs, including (Aerobics – Fitness – Yoga) programs. These programs are designed specifically for the university female students, faculty members, and teaching assistants. they are held twice a week with the participation of female students from most of the university's faculties.



### Sports Activities and Courses

## 6. Do Understand Me short film

The Faculty of Mass Communication produces a short film on deafness and hearing impairment (Do Understand Me) which addresses different activities of persons with disabilities and how to include them day to day living conditions

<https://www.youtube.com/watch?v=HwoLx5Q3gvE&list=PLsZ1HNiwxSAPBp9Ff74mHK1NbRVLCp-52&index=9>



## 7. Faculty of Engineering Visits a Nursing Home

Within the framework of Pharos University's keenness to play its role in community service, the Community Service Committee of the Faculty of Engineering, in cooperation with the Student Activities Committee and the Khair Team Family, organized a visit to the Health Improvement Home in Al Ras Al-sawdaa on Sunday, March 27, 2022. The visit was



under the supervision of the Activities Department, along with several Faculty students and Khair Team Family, with the supervision of Eng. Amr Mamdouh, Teaching Assistant, Department of Mechanical Engineering, Faculty of Engineering. The students celebrated with the home mothers on Mother's Day.

[Faculty of Engineering Visits a Nursing Home](#)



## 10.3 – Students' Projects

### Stair Climber

**Abstract:** The project introduces an engineering, practical, daily, easy in use solution for all wheelchair users, who suffer in public buildings or even in streets daily as stairs represent a barrier to their transportation that can't be crossed unless an external and a strong hand is provided.

A detailed engineering machine is designed to ascend and descend any public steps safely and automatically without any external help, to be practical during daily life for users, to be controlled using bottoms without complexity. The project was divided into six stages: brain- storming stage, filtration stage, try and error stage, design stage, calculation stage and building a prototype.

The project idea was carefully chosen after discussing different ideas with different applications and concepts, in the brain-storming stage in meetings. Each of which was being analyzed mechanically, mathematically, and financially with an engineering perspective to conclude which idea was to be chosen which made the filtration stage easier and faster.

Proposed ideas were filtered and finally the wheelchair proposed mechanism was selected. Due to the latest launch of such a product in the world, no strong references were found, try and error stage took place. Before working on the final mechanism, several mechanisms were rejected due to some faced problems, either in factor of safety, overall efficiency, or unsuitable physical dimensions.

The stair-climber was designed from scratch in the design stage. AutoCAD drawings for the chosen design were to be completed, Therefore, mechanical mechanisms were built up together and connected to invent the required relative motion which is the main key to the main goal of the project. All necessary calculations were done in the final stage.

After the design is drawn in details, calculations were done to identify accurate physical dimensions corresponding to applied forces, electrical motors power corresponding to the required torque, battery capacity suitable for the application and according to recharging time and continuous working time in addition to force and stress analysis for critical parts used.

The aim, behind the project, is to practice designing and building up one detailed machine with a helpful purpose for humanity. A machine that facilitates daily actions and affords life for those who thought they couldn't have one, then they can resume their lives, participate freely in society, and have the basic





qualifications to get a job. Not only that, but also to practice on some software programs mainly AutoCAD and Mathcad. In addition to afford such invention to our home country with a lower price compared to launched products which costs around 15,000 euro, approximately equivalent to 287,900 Egyptian pounds and it is estimated to launch the chair here in Egypt with average 45,000 Egyptian pounds only.

The thesis is organized as follows: Chapter (1) (Introduction)

1.1 Brainstorming: Introduces initial steps done in meetings, brainstorming stage took place, time, and effort. Proposed machine ideas were carefully analyzed mechanically, mathematically, and financially with respect to the engineering perspective.

1.2 Wheelchair: Clarifies the benefits and additions the wheelchair affords to human life, and what it capable of adding to humanity. Explains what a wheelchair is, how humanity needs them, what are the rights of wheelchairs and how does they affect the economy.

1.3 Stair Climber: Explains how wheelchair users still suffer and have barriers during transportation, what makes transporting across the city using a wheelchair difficult and what might be the problem when help is asked. It is explained the right technique as well to ascend and descend a wheelchair user stair without slipping or damage. It is clarified what updates are recommended to be done and what benefits humanity is gaining from the recommended update. Chapter (2) (Try and error stage) After the machine application was carefully chosen, not only to be learnt but also to be a great addition to humanity and affords lives for those who are in need. According to the progress it was the turn to estimate what mechanisms and design is preferred to be studied among the proposed designs. All proposed designs were mentioned, briefly explained, besides the noticed advantages and disadvantages were explained logically. Some designs already exist, and it was marked.

Chapter (3) (Stair-Climber Design) 3.1 Standards: 3.1.1 Steps and Stairs Standards Listing international standards needed to be known and taken as main reference, regarding the step's dimensions, inclination, and detailed information. 3.1.2 Disabled Chair Standards According to the World Health Organization (WHO), there is some restriction should be kept in mind during designing a wheelchair for the sake of the user. They are listed and clarified. 3.2 Stair Climber Design: The chosen mechanism was to be in detail drawn and clarified using SolidWorks drawings. All main mechanisms were clarified and explained, in addition to a drawing for the assembly. The machine consists of three main mechanisms that



were to be in detail explained, clarifying each component concept and function. All parts were illustrated with detailed drawings. 3.2.1 Belt Mechanism 3.2.2 Balancing Mechanism 3.2.3 Wheel Mechanism Chapter (4) (Calculation) Calculations were done using Mathcad. To estimate motor power, material requirements, stress analysis, force analysis...etc. Chapter (5) (Prototype) The chapter includes some captured pictures, that were taken during the process of building the prototype.

#### 10.4 – Courses in Curricula

Faculty	Course name	Course code	SDG-relevancy	Topic
Pharmacy	Pharmacotherapeutics for special population	PL E23	SDG 10	Wellbeing of special needs population
Pharmacy	Home health care	PN E19	SDG 10	Wellbeing of women health at home
Artificial intelligence	Speech recognition	AI402	SDG 10	Education for special needs to reduce inequalities
Artificial intelligence	Language processing	AI407	SDG 10	Education for special needs to reduce inequalities
Physical Therapy	Public Health	PTBA 216	SDG 10	Good health of society particularly for poor
Physical Therapy	Psychology of Handicapped	PTBA 217	SDG 10	Psychic problem and treatment
Law	Labor and social security law	LV 06	SDG 10	Social security issues
Business	Business and society	BF 747	SDG 10	The course discussed the relationship between business and society in terms of achieving equality through social corporate responsibility



## SDG 11 – Sustainable Cities and Communities

### 11.1 – Conferences and Workshops

<https://www.pua.edu.eg/sustainability-competition/>

Within the sustainability week launched by the Tourism Department, 3rd year students in the tourism impact and sustainability course – as part of their final dissertation – presented a set of creative ideas. These ideas reflected the concept of sustainability and its significance for tourist destinations

The students were divided into a group of competing teams, under the supervision of Assoc. Prof. Dr. Ghada Bassiouni, and Prof. Amr Moroccan. Each team was keen on implementing an idea that reflects the concept of sustainability in tourist destinations.

This was done by designing posters, fliers, and magazines, that highlighted the extent to which they have acquired the learning skills targeted in the course specification.





## Climate Conference

<https://www.pua.edu.eg/climate-conference-2/>

A high-level delegation from Pharos University participated in the “Future of Alexandria and Climate Challenges” conference held at the Bibliotheca Alexandrina on Tuesday, March 29, 2022, which was co-sponsored by Pharos University. The delegation included Prof. Dr. Mahmoud Mohy El-Din, President of the University, Prof. Dr. Prof. Nourhan Fanaky, Vice-President for Education and Student Affairs, Prof. Dr. Prof. Ramadan Abu El-Ala, Vice President of Community Service & Environment Development Affairs, Prof. Dr. Boshra Salem, Dean of Postgraduate Studies and Research, and Prof. Dr. Ramadan Abdel Maksoud, Supervisor of the Department of Architecture, Faculty of Engineering, along with several university students. Further, the delegation members participated in the important discussions and recommendations produced from the sessions held in this regard.





## 11.2 – Activities

### Department of Electrical Engineering in The First Egyptian Hackathon for Smart Cities

<https://www.pua.edu.eg/department-of-electrical-engineering-in-the-first-egyptian-hackathon-for-smart-cities/>

Within the framework of its interest in participating in major local events, the student from the Department of Electrical Engineering is currently participating in the activities of the first Egyptian Hackathon for Smart Cities at the national level. The event was held at Benha University from March 24 to March 26, 2022, under the patronage of His Excellency the Minister of Higher Education and Scientific Research, and in partnership with the Amazon Web Service.

Benha University, as the organizer of the event, announced that 478 teams representing 50 Egyptian public, private, and national universities applied to participate in the hackathon. The teams were later shortlisted to only 40 teams representing 25 universities.

The electrical engineering department team was chosen as the sole representative of Pharos University. The team includes five students from the fifth year, namely: Mohamed Abdel Azeem, Fayza Abdel Fattah Mohammad, Ahmed Khalil, Seif El-Din Mahmoud, Mohammad Ali Ahmed. Further, the project presented was supervised by Prof. Dr. Ahmed Abdullah. The team is also accompanied by Eng. Abdul Rahman Khaled, teaching assistant, as a supervisor.

Prof. Dr. Muhammad Abdul Rahman, Academic Supervisor of the Electrical Engineering Department, said that the 25 teams compete in ten different fields, including smart buildings, smart parks, smart schools and universities, smart facilities, smart management, and others.

Furthermore, the event coincides with the biggest current challenges of the Egyptian state, which is digitization and smart digital transformation. Prof. Dr. Muhammad Abdul Rahman also stressed the importance of the participation of Pharos University and its students in these major competitions and forums which allow students to acquire the necessary skills for competition, challenge, and innovation. Further, to honor the university's quest in the adoption of engineering educational competencies that keep pace with the requirements of the times.





### Pharos University Organized “Towards Sustainable Tomorrow” Competition

<https://www.pua.edu.eg/pharos-university-organized-towards-sustainable-tomorrow-competition/>

The faculty of Engineering organized the “Towards Sustainable Tomorrow” competition sponsored by Birla Carbon Egypt for the third year in a row. This was held on Tuesday, 28 July 2020. The competition aims to choose creative projects that serve sustainability. The value of 36000 LE was allocated for the awards of the first three places: 17000 LE for the 1st place, 12000 LE for the 2nd place and 7000 for the 3rd place. It is worth mentioning that 6 projects participated in this competition from Electrical Engineering, Mechanical Engineering, Petrochemical Engineering Departments. The judging panel was comprised of:

- Mona Gamal Eldeen, the Dean of the School of Energy Resources, Environment, Chemical and Petrochemical Engineering at the Egypt-Japan University of Science and Technology. (Head of the judging panel)
- Waael Almaghlany, the Head of Mechanical Engineering Department at Alexandria University.
- Boshra Salem, the Consultant of the President of the University for International Relations and Projects.
- Mohamed Naeem, the Vice Dean of the Faculty of Engineering.

The electrical engineering project “IoT Approach for Sustainable Green Campus” won 2nd place in the competition. It was submitted under the supervision of Dr. Mohammed Adb El Karim.

Petrochemical Engineering Department participated with 2 projects:



- “Synthesis of Ion Exchange Resins for Ammonia Removal Based on Waste Polymers” which was submitted under the supervision of Dr. Rania Farouk.
- “Recycling of Polyester Fabric Scraps” won 3rd place in the competition. It was submitted under the supervision of Dr. Ehsan Nafed.

Mechanical Engineering Department participated with 3 projects:

- “Design, Modeling and Performance Analysis of Solar Still” which was submitted under the supervision of Dr. Mohamed El Saied Youssef.
- “Design and Optimization of Network Solar” won 1st place in the competition. It was submitted under the supervision of Dr. Mohamed El Naqib.
- “Home Scale Vertical Axis Wind Turbine (VAWT)” won 2nd place in the competition. It was submitted under the supervision of Dr. Sameh Tawfik.





## Pharos Contributions in the “Live Green” Presidential Initiative

<https://www.pua.edu.eg/pharos-contributions-in-the-live-green-presidential-initiative/>

Prof. Ramadan Abu El-Ala, the Vice President of Community Service and Environment Development Affairs and Prof. Hesham El Shimy, the Director of the Community Service and Environmental Development Centre (CSED) participated in a meeting about the “Live Green” initiative. The meeting was held in Alexandria Governorate Office on Wednesday, 12 February 2020.

The meeting was attended by Mr. Ahmed Gamal, the Deputy Governor of Alexandria, and representatives from all concerned authorities in the governorate. This meeting aimed to discuss the mechanisms to apply the “Live Green” initiative launched by the President of Egypt to raise environmental awareness in Alexandria. During the meeting, Mr. Ahmed Gamal stressed the importance of the consultative role of Pharos University which came within the framework of the government keenness to achieve cooperation and integration by taking advantage of the experiences of the scientific bodies in Alexandria and working hand in hand for the benefit of the governorate.

In addition, Prof. Hesham El Shimy showed the attendees a study on “Harmonic Mechanisms for Treating all Types of Wastewater to Irrigate a Sustainable Green Belt to Protect the Vicinity of Lake Mariout.” It is worth mentioning that the study impressed all the attendees, and it was stressed upon the need for adopting that study by the governorate and other authorities at the local and central levels. At the end, the Deputy Governor asked for an electronic copy of the study to put it into practice.



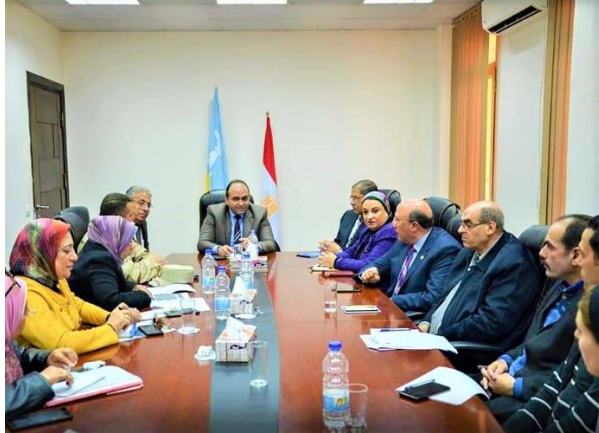



### 11.3 – Publications

No.	TITLE/YEAR/AUTHORS	DOI
1	Improving urban park usability in developing countries: Case study of Al-Shalalat Park in Alexandria 2020 Alexandria Engineering Journal	10.1016/j.aej.2019.12.042
	Abdelhamid, M.M.   Elfakharany, M.M.	
	Pharos University in Alexandria	
2	LEED v4.1 operations & maintenance for existing buildings and compliance assessment: Bayt Al-Suhaymi, Historic Cairo 2020 Alexandria Engineering Journal	10.1016/j.aej.2020.01.027
	ElSorady, D.A.   Rizk, S.M.	
	Pharos University in Alexandria   Beni-Suef University	
3	Adaptive Reuse Decision Making of a Heritage Building Antoniadis Palace, Egypt 2020 International Journal of Architectural Heritage	10.1080/15583058.2018.1558313
	Elsorady, D.A.	
	Pharos University in Alexandria	
4	Functionalization of CeO <sub>2</sub> -SiO <sub>2</sub> -(CH <sub>2</sub> ) <sub>3</sub> -Cl nanoparticles with sodium alginate for enhanced and effective CdII, PbII, and ZnII ions removal by microwave irradiation and adsorption technique 2020 Environmental Nanotechnology, Monitoring and Management	10.1016/j.enmm.2020.100367
	El-Sharkawy, R.M.   Allam, E.A.   Mahmoud, M.E.	
	Pharos University in Alexandria   Alexandria University	
5	Mapping UML sequence diagram into the web ontology language OWL 2020 International Journal of Advanced Computer Science and Applications	10.14569/IJACSA.2020.0110542
	Elsayed, M.   Elkashef, N.   Hassan, Y.F.	
	Pharos University in Alexandria   Alexandria University	
6	Assessment of coverage quality of sensor networks for IoT applications 2020 Peer-to-Peer Networking and Applications	10.1007/s12083-019-00796-2
	Elsaadany, A.   Khalil, K.	
	Pharos University in Alexandria	





No.	TITLE/YEAR/AUTHORS	DOI
7	A Fuzzy, Incremental and Semantic Trending Topic Detection in Social Feeds 2020 2020 11th International Conference on Information and Communication Systems, ICICS 2020	10.1109/ICICS49469.2020.239492
	Abou-Of, M.A.	
	Pharos University in Alexandria	
8	A review on steel surface image features extraction and representation methods 2020 Lecture Notes of the Institute for Computer Sciences, Social-Informatics and Telecommunications Engineering, LNICST	10.1007/978-3-030-60036-5_17
	Ashour, M.W.   Khalid, F.   Halin, A.A.   Darwish, S.H.   Abdulrazzaq, M.M.	
	Pharos University in Alexandria   Universiti Putra Malaysia   International Islamic University Malaysia	
9	The influence of social media marketing on consumer purchase intention of fresh produce in Egypt 2020 Proceedings of the 7th European Conference on Social Media, ECSM 2020	10.34190/ESM.20.009
	Ragab, I.   Ragab, M.A.F.	
	Pharos University in Alexandria	
10	Evaluating the legibility of complex buildings: A quantitative model for indoor wayfinding 2020 WIT Transactions on Ecology and the Environment	10.2495/SC200121
	Ahmed, S.H.   Taha, D.S.   Hasan, A.E.	
	Pharos University in Alexandria   Alexandria University	
11	Predicting Stock Market Trends for Japanese Candlestick Using Cloud Model 2020 Advances in Intelligent Systems and Computing	10.1007/978-3-030-44289-7_59
	Madbouly, M.M.   Elkholy, M.   Gharib, Y.M.   Darwish, S.M.	
	Pharos University in Alexandria   Alexandria University	



No.	TITLE/YEAR/AUTHORS	DOI
12	Sustainable Touristic path toward cultural identity 2020 Journal of Engineering Research	10.21608/erj.2020.145854
	Ragheb, R.A.   Naguib, I.M.	
	Pharos University in Alexandria	
13	H-Seed: Vision for smart city 2020 WIT Transactions on Ecology and the Environment	10.2495/SDP200091
	Shehata, H.M.   Bakr, A.F.   Hassan, A.	
	Pharos University in Alexandria   Alexandria University	

#### 11.4 – Courses in Curricula

No	Faculty in Pharos University	Course name	Course code	SDG of relevance	Topics in each course
1	Engineering	Renewable energy and storage systems	EM 333	SDG 11	Different methods of energy storage systems, : electrical energy lightening, energy saving, heat energy saving, insulation, solar energy, smart building, equipment design, sensors and computer- controlled processes.



## SDG 12 – Responsible Consumption and Production

### 12.1 – Conferences and Workshops

#### Recycling Fabric Wastes and Scraps to Achieve Sustainability Workshop

<https://www.pua.edu.eg/?s=Recycling+Fabric+Wastes+and+Scraps+to+Achieve+Sustainability+Workshop>

As part of PUA's student activities program, the Faculty of Arts and Design organized a workshop entitled "Recycling Fabric Wastes and Scraps to Achieve Sustainability." This workshop was prepared by Dr. Marwa Issa, Lecturer in the Fashion Design Department.

Despite the increasing attention to environmental issues and conservation, fabric scraps are still being wasted throughout the various stages of design and execution. Till today, the surplus in fabric scraps has no clear mechanism to utilize it.

Therefore, this workshop presents a new vision for utilizing the remnants of fabric waste and scraps. This can be done through merging the various patterns of the fabrics with basic materials, auxiliary materials, while observing compatibility.





## Recycling Pottery Using Environment-Friendly Colorants Workshop

<https://www.pua.edu.eg/?s=Recycling+Pottery+Using+Environment-Friendly+Colorants+Workshop>

The Faculty of Art and Design organized a workshop entitled “Recycling Pottery Using Environment-Friendly Colorants.” The workshop took place on Tuesday, April 19, 2022, in Room B431. It was delivered by Dr. Sherine Mokhtar, who gave a definition of this industry, its significance, and the benefits of storing food and drinks inside it. The aim of this workshop was to encourage the use of environment-friendly products and re-producing them in an innovative artistic way.





### Pharos University to Foster Ties with the Industrial Modernization Centre

<https://www.pua.edu.eg/?s=Pharos+University+to+Foster+Ties+with+the+Industrial+Modernization+Centre>

Prof. Ramadan Abu El-Ala, the Vice President of Community Service and Environment Development Affairs, along with Prof. Hana Yassin, the Dean of the Faculty of Arts and Design- Pharos University held a meeting with some representatives of both branches of the Industrial Modernization Centre (IMC) in Cairo and Alexandria and the Coordinator of the Innovation Programs in Nile University and NilePreneurs Initiative. The distinguished guests included the following:

1. Hisham Mohamed Sayed Basha, the Deputy Director of the Industrial Modernization Centre (IMC)
2. Ahmed Hossam El Din, an expert in business development
3. Ibrahim Atashy Ibrahim, the Head of the Industrial Modernization Centre (IMC) in Borg Al Arab – Alexandria
4. Mohamed Abbas Gomaa, the Coordinator of the Innovation and Technological Incubators Programme.

This was held in the presence of Dr. Shaimaa Khodair, the Head of the Training Unit at the faculty of Arts and Design. During the meeting, means of cooperation were sought between Pharos University on one side and the Industrial Modernization Centre (IMC) and the whole industrial sector in Alexandria on the other side, in concern with the realm of field training as well as the implementation of the students' graduation projects. It also discussed the





possibility of the participation of Pharos University in providing solutions to some of the problems encountered by the industrial sector in Alexandria. At the end of the meeting, Prof. Ramadan Abo El-Ala called for another meeting between Pharos University and the Industrial Modernization Centre (IMC) to work on achieving the goals of the community service sector in Pharos University and finding solutions for the problems of the industrial sector in Alexandria.





## “Significance of a Vegetarian Diet on Health and Environment” Seminar

<https://www.pua.edu.eg/?s=%E2%80%9CSignificance+of+a+Vegetarian+Diet+o+n+Health+and+Environment%E2%80%9D+Seminar>

The Faculty of Health and Applied Science Technology organized a seminar entitled “Significance of a Vegetarian Diet on Health and Environment” on Tuesday 19/4/2022. The seminar was held under the supervision of Prof. Dr. Ezzat Hassan, Dean of the Faculty of Health and Applied Science Technology, and Prof. Dr. Hamdy Al-Wakeel, Vice Dean for Education and Student Affairs, and in the presence of several Faculty students. This event was held as part of the activities of the Scientific Committee of Student Activities Department. Dr. Duha Abu Zahra and students/ Muhammad Essam and Nada Hamida participated in the seminar by making a poster on the food pyramid for vegetarians. Students/ Rodina Adly and Sandy Mohamed also participated by explaining the benefits and harms of vegetarian diet.





### Field Visit to the Alexandria Petroleum Company

<https://www.pua.edu.eg/field-visit-to-the-alexandria-petroleum-company/>

The Mechanical Engineering Department organized a field visit to the Alexandria Petroleum Company for 40 of its students from different academic levels for one full day. The students were accompanied by several Department professors.

At the beginning, the company lectured the students about the company's activities, stages of separating petroleum and distilling it into its various constituents. As well as the mechanical devices and equipment used to raise pressure, heating, evaporation, and distillation towers.

After that, engineers from the company took the students on a field tour to see what was demonstrated on the ground. It is worth noting that the company's training and human development officials commended the students' passion and interest in the practical side. As well as their good behavior and commitment during the visit.





## Faculty of Engineering Organizes a Workshop: Industry 4.0 and Digital Twinning in Effective Teaching

<https://www.pua.edu.eg/faculty-of-engineering-organizes-a-workshop-industry-4-0-and-digital-twinning-in-effective-teaching/>

Due to the implications of industry 4.0, major changes occurred to the businesses that strongly affected manufacturing processes and competitive features of local and international companies, industries, and systems.

In this regard, Faculty of Engineering, PUA organized a workshop that aims at contributing in the discussion on the effect of Industry 4.0 through surveying academic and industrial viewpoints. This can be done through the application of the technologies of the 21st century Industry 4.0. These technologies include Smart Manufacturing, Industrial Internet of Things, PC-based Controls, Autonomous Things (AuT), AR/VR, Artificial Things, which are considered the core of Industry 4.0.



The workshop was followed by a general lecture for the interested students to discuss a variety of major scientific topics such as (AI, Cloud Computing, Self-Driving Cars) and their relevance to the job market.



### Faculty of Legal Studies' Charity Market

<https://www.pua.edu.eg/faculty-of-legal-studies-charity-market/>

As part of the student activities, the Faculty of Legal Studies organized a charity market to distribute Ramadan supplies to the workers free of charge. The market that took place on Wednesday, April 20, 2022, at 1:00 pm, was opened by Prof. Dr. Ramadan Abu El Ala, Vice President for Community Service and Environmental Development, and Prof. Dr. Hammam Zahran, Dean of the Faculty of Legal Studies. Further, it was attended by a group of faculty members and teaching assistants, along with many students.







## Qawafel Al Khair Drive off of PUA

<https://www.pua.edu.eg/qawafel-al-khair-drive-off-of-pua/>

In continuation of the annual tradition which the University's administration is keen on and based on its pioneering role in the field of community service, PUA hosted on Friday, April 1, on the university playground, the annual celebration of the Orphan's Day.

About 300 children, from 6 civil associations concerned with the care of orphans participated in the event. These associations included: "Naba'a Al Hob Charitable Society, Al Istekrar Charitable Society, Al Mutadaro'on Charitable Society, Al Qala'a Society for Community Development, Tariq Al-Khair Society for Community Development, and Mujib Al-Sayyilin Charitable Society". Furthermore, many faculty members, teaching assistants, along with many students participated with great enthusiasm in organizing the event.

The children participated in the various games and activities that the Faculty of Dentistry participated in. The faculty also spread awareness among the children by presenting them with gifts related to the prevention and protection of teeth. In a similar context, The Faculty of Engineering participated in some recreational games, while the Faculty of Arts participated in face painting and distrusting handicraft gifts. The Faculties of Languages and Translation, Tourism, and Financial and Administrative Sciences also participated in distributing gifts. The Faculty of Medical Sciences, however, provided awareness about proper nutrition and healthy foods, in addition to distributing some gifts to children.

Moreover, the event included theatrical, musical, wizard, and Nubian skits performed. At the end of the ceremony, meals and clothes were distributed, and as followed in the annual tradition, commemorative group photos were taken.



## Pharos Contributions in the “Live Green” Presidential Initiative

<https://www.pua.edu.eg/pharos-contributions-in-the-live-green-presidential-initiative/>

Prof. Ramadan Abu El-Ala, the Vice President of Community Service and Environment Development Affairs and Prof. Hesham El Shimy, the Director of the Community Service and Environmental Development Centre (CSED) participated in a meeting about the “Live Green” initiative. The meeting was held in Alexandria Governorate Office on Wednesday, 12 February 2020.

The meeting was attended by Mr. Ahmed Gamal, the Deputy Governor of Alexandria and representatives from all concerned authorities in the governorate. This meeting aimed to discuss the mechanisms to apply the “Live Green” initiative launched by the President of Egypt to raise environmental awareness in Alexandria. During the meeting, Mr. Ahmed Gamal stressed the importance of the consultative role of Pharos University which came within the framework of the government keenness to achieve cooperation and integration by taking advantage of the experiences of the scientific bodies in Alexandria and working hand in hand for the benefit of the governorate.

In addition, Prof. Hesham El Shimy showed the attendees a study on “Harmonic Mechanisms for Treating all Types of Wastewaters to Irrigate a Sustainable Green Belt to Protect the Vicinity of Lake Mariout.” It is worth mentioning that the study impressed all the attendees, and it was stressed upon the need for adopting that study by the governorate and other authorities at the local and





central levels. At the end, the Deputy Governor asked for an electronic copy of the study to put it into practice.

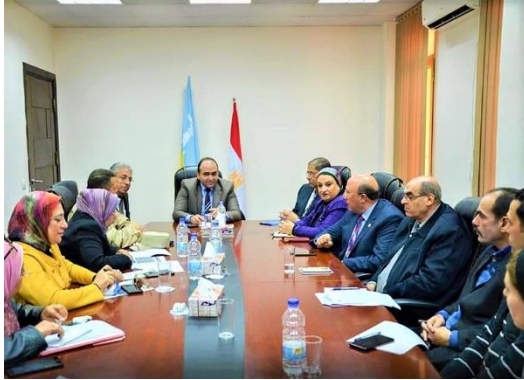

## Intra Africa 2063 Competition

<https://www.pua.edu.eg/intra-africa-2063-competition/>

Pharos University in Alexandria organizes a virtual “Design thinking and Ideation camp” through E-Club PUA in cooperation with the African Union and the Egyptian Academy of Scientific Research and Technology, the camp targets students, and graduates of PUA and African Union universities.

The camp is held from 26-29 July 2021 aiming at motivating African youth towards “Social Entrepreneurship” to trigger innovative ideas that serve the goals of development and sustainability in the African societies.



## 12.1 – Responsible Consumption and Production Activities: Proportion of Recycled Waste:

Indicator	Amount in Metric Ton
Amount of waste generated	23.988
Amount of waste recycled	21.108
Amount of waste sent to landfill	2.88





### 12.3 – Publications

No.	TITLE/YEAR/AUTHORS	DOI
1	Investigation of mechanical and radiation shielding characteristics of novel glass systems with the composition $x\text{NiO}-20\text{ZnO}-60\text{B}_2\text{O}_3-(20-x)\text{CdO}$ based on nanometal oxides 2020 Journal of Non-Crystalline Solids	10.1016/j.jnoncrysol.2019.119754
	El-Sharkawy, R.M.   Shaaban, K.S.   Elsaman, R.   Allam, E.A.   El-Taher, A.   Mahmoud, M.E.	
	Al-Azhar University   Alexandria University	
2	Characterization of the efficiency of a cubic NaI detector with rectangular cavity for axially positioned sources 2020 Journal of Instrumentation	10.1088/1748-0221/15/02/P02013
	Badawi, M.S.   Nouredine, S.   Kopatch, Y.N.   Abbas, M.I.   Ruskov, I.N.   Grozdanov, D.N.   Thabet, A.A.   Fedorov, N.A.   Gouda, M.M.   Hramco, C.   Abd-Elzaher, M.   Hamzawy, A.   Elsafi, M.   El-Khatib, A.M.	
	Arab Academy for Science, Technology and Maritime Transport   Beirut Arab University   Umm Al-Qura University   Joint Institute for Nuclear Research   Lebanese University   Bulgarian Academy of Sciences   Academy of Sciences of Moldova   Lomonosov Moscow State University   Alexandria University	



No.	TITLE/YEAR/AUTHORS	DOI
3	Efficiency of a cubic NaI(Tl) detector with rectangular cavity using standard radioactive point sources placed at non-axial position 2020 Applied Radiation and Isotopes	10.1016/j.apradiso.2020.109139
	Abbas, M.I.   Badawi, M.S.   Thabet, A.A.   Kopatch, Y.N.   Ruskov, I.N.   Grozdanov, D.N.   Nouredine, S.   Fedorov, N.A.   Gouda, M.M.   Hramco, C.   Abd-Elzaher, M.   Hamzawy, A.   Elsafi, M.   El-Khatib, A.M.	
	Arab Academy for Science, Technology and Maritime Transport   Beirut Arab University   Umm Al-Qura University   Joint Institute for Nuclear Research   Lebanese University   Bulgarian Academy of Sciences   Academy of Sciences of Moldova   Lomonosov Moscow State University   Alexandria University	
4	Investigation of $\gamma$ -ray attenuation coefficients, effective atomic number and electron density for ZnO/HDPE composite 2020 Physica Scripta	10.1088/1402-4896/ab9a6e
	Alsayed, Z.   Badawi, M.S.   Awad, R.   El-Khatib, A.M.   Thabet, A.A.	
	Beirut Arab University   Alexandria University	
5	Simultaneous analysis of chlorzoxazone, diclofenac sodium and tramadol hydrochloride in presence of three potential impurities using validated HPLC-DAD and HPTLC methods 2020 Microchemical Journal	10.1016/j.microc.2019.104505
	Ahmed, H.M.   Elshamy, Y.S.   Talaat, W.   Labib, H.F.   Belal, T.S.	
	Arab Academy for Science, Technology and Maritime Transport   Menoufia University   Alexandria University   Damanhour University	



No.	TITLE/YEAR/AUTHORS	DOI
6	Pyrolysis of low-density polyethylene waste plastics using mixtures of catalysts 2020 Journal of Material Cycles and Waste Management	10.1007/s10163-020-01028-z
	Soliman, A.   Farag, H.A.   Nassef, E.   Amer, A.   ElTaweel, Y.	
	Alexandria University	
7	Improving urban park usability in developing countries: Case study of Al-Shalalat Park in Alexandria 2020 Alexandria Engineering Journal	10.1016/j.aej.2019.12.042
	Abdelhamid, M.M.   Elfakharany, M.M.	
	Pharos University in Alexandria	
8	LEED v4.1 operations & maintenance for existing buildings and compliance assessment: Alexandria Engineering Journal	10.1016/j.aej.2020.01.027
	Bayt Al-Suhaymi, Historic Cairo 2020 ElSorady, D.A.   Rizk, S.M.	
	Beni-Suef University	
9	Effect of drag reducing polymers and impeller geometry on the rate of mass and heat transfer at the wall of a cylindrical stirred tank reactor in relation to catalytic reactor design 2020 Alexandria Engineering Journal	10.1016/j.aej.2020.01.025
	Shokry, F.   Abd Elfattah, M.   El-Gayar, D.A.   Farag, H.A.   Sedahmed, G.H.	
	Alexandria University	
10	Extensive theoretical study of gamma-ray shielding parameters using epoxy resin-metal chloride mixtures 2020 Nuclear Technology and Radiation Protection	10.2298/NTRP2002138M
	More, C.V.   Pawar, P.P.   Badawi, M.S.   Thabet, A.A.	
	Beirut Arab University   Dr. Babasaheb Ambedkar Marathwada University   Alexandria University	



No.	TITLE/YEAR/AUTHORS	DOI
11	Centralized dynamic channel reservation mechanism via SDN for CR networks spectrum allocation 2020 IEEE Access	10.1109/ACCESS.2020.3032666
	El Azaly, N.M.   Badran, E.F.   Kheirallah, H.N.   Farag, H.H.	
	Arab Academy for Science, Technology and Maritime Transport   Alexandria University	
12	Functionalization of CeO <sub>2</sub> -SiO <sub>2</sub> -(CH <sub>2</sub> ) <sub>3</sub> -Cl nanoparticles with sodium alginate for enhanced and effective Cd <sup>II</sup> , Pb <sup>II</sup> , and Zn <sup>II</sup> ions removal by microwave irradiation and adsorption technique 2020 Environmental Nanotechnology, Monitoring and Management	10.1016/j.enmm.2020.100367
	El-Sharkawy, R.M.   Allam, E.A.   Mahmoud, M.E.	
	Alexandria University	
13	New mathematical approach to calculate the geometrical efficiency using different radioactive sources with gamma-ray cylindrical shape detectors 2020 Nuclear Engineering and Technology	10.1016/j.net.2019.11.022
	Thabet, A.A.   Hamzawy, A.   Badawi, M.S.	
	Beirut Arab University   Umm Al-Qura University	
14	Evolutionary computation technique enhancing the performance of cognitive radio networks with energy harvesting 2020 Ad Hoc Networks	10.1016/j.adhoc.2020.102254
	El-Malek, A.H.A.   Aboulhassan, M.A.   Abdou, M.A.	
	City for Scientific Research and Technology Applications   Egypt-Japan University of Science and Technology	



No.	TITLE/YEAR/AUTHORS	DOI
15	Nano-manganese oxide-functionalized-oleyamine as a simple and low cost nanosorbent for remediation of ZnII/CoII and their radioactive nuclides 65Zn and 60Co from water 2020 Applied Radiation and Isotopes	10.1016/j.apradiso.2019.108989
	Mahmoud, M.E.   Allam, E.A.   El-Sharkawy, R.M.   Soliman, M.A.   Saad, E.A.   El-Khatib, A.M.	
	Ain Shams University   Egyptian Atomic Energy Authority   Alexandria University	
16	New video encryption schemes based on chaotic maps 2020 IET Image Processing	10.1049/iet-ipr.2018.5250
	Elkamchouchi, H.   Salama, W.M.   Abouelseoud, Y.	
	Alexandria University	
17	Room temperature synthesis of aqueous ZnCuInS/ZnS quantum dots 2020 Journal of Dispersion Science and Technology	10.1080/01932691.2019.1645022
	El Nady, J.   Ali, M.   Kamel, O.A.   Ebrahim, S.   Soliman, M.	
	City for Scientific Research and Technology Applications   Alexandria University	
18	Validated Capillary Zone Electrophoretic Method for Simultaneous Analysis of Benazepril in Combination with Amlodipine Besylate and Hydrochlorothiazide 2020 Acta Chromatographica	10.1556/1326.2019.00686
	Ahmed, H.M.   Belal, T.S.   Shaalan, R.A.   Yazbi, F.A.E.   Elonsy, S.M.	
	Menoufia University   Alexandria University   Damanhour University	
19	Optimization of photocatalytic degradation of methylene blue dye using titanate nanotube 2020 Journal of Nanophotonics	10.1117/1.JNP.14.026008
	Tayeb, A.M.   Hussein, D.S.   Farouq, R.	
	Minia University	





No.	TITLE/YEAR/AUTHORS	DOI
20	A flexible ergonomic redesign of the sewing machine workstation 2020 Research Journal of Textile and Apparel	10.1108/RJTA-10-2019-0050
	Eladly, A.M.   Abou-Ali, M.G.   Sheta, A.M.   EL-Ghlomy, S.H.	
	Alexandria University	
21	Antibacterial activity of some nanoparticles prepared by double arc discharge method 2020 Nano-Structures and Nano-Objects	10.1016/j.nanoso.2020.100473
	El-Khatib, A.M.   Doma, A.S.   Abo-Zaid, G.A.   Badawi, M.S.   Mohamed, M.M.   Mohamed, A.S.	
	City for Scientific Research and Technology Applications   Beirut Arab University   University of Sadat City   Alexandria University	
22	Validated spectrofluorimetric method for determination of mirabegron by utilizing its quenching effect on acetoxymurcuric fluorescein reagent 2020 Part A: Molecular and Biomolecular Spectroscopy	10.1016/j.saa.2020.118509
	Morshedy, S.   Omran, G.   Abdullatef, O.A.   Omar, M.   Talaat, W. Spectrochimica Acta -	
	Damanhour University	
23	The Inhibitory Effect of Wheat Husks Addition on Aflatoxins Production by Aspergillus flavus in Liquid Culture With Various Wheat Compositions as Carbon Sources 2020 Frontiers in Microbiology	10.3389/fmicb.2020.01448
	Ghanem, K.M.   Lotfy, W.A.   El-Shaer, M.M.   Elassar, S.A.	
	Alexandria University	
24	Thermal and potentiometric studies for complexes of Zr and Hf with some barbituric acid derivatives 2020 IOP Conference Series: Materials Science and Engineering	10.1088/1757-899X/975/1/012015
	Masoud, M.S.   Hassan, A.S.   Desouky, N.M.   Kamel, H.M.   El-Kholany, A.S.	
	Alexandria University	



No.	TITLE/YEAR/AUTHORS	DOI
25	Gradient HPLC-DAD method for quantification of novel oral anticoagulant "Edoxaban" in plasma: Its selective determination in presence of sixteen co-administered drugs 2020 Journal of Chromatography B: Analytical Technologies in the Biomedical and Life Sciences	10.1016/j.jchromb.2020.122386
	Younis, S.E.   El-Nahass, S.A.   Elkhatib, M.A.W.   Soliman, S.A.   Youssef, R.M.	
	Alexandria University	
26	Mapping UML sequence diagram into the web ontology language OWL 2020 International Journal of Advanced Computer Science and Applications	10.14569/IJACSA.2020.0110542
	Elsayed, M.   Elkashef, N.   Hassan, Y.F.	
	Alexandria University	
27	Assessment of coverage quality of sensor networks for IoT applications 2020 Peer-to-Peer Networking and Applications	10.1007/s12083-019-00796-2
	Elsaadany, A.   Khalil, K.	
	Pharos University in Alexandria	
28	A Fuzzy, Incremental and Semantic Trending Topic Detection in Social Feeds 2020 Abou-Of, M.A. 2020 11th International Conference on Information and Communication Systems, ICICS 2020	10.1109/ICICS49469.2020.239492
	Ashour, M.W.   Khalid, F.   Halin, A.A.   Darwish, S.H.   Abdulrazzaq, M.M.	
	Pharos University in Alexandria	
29	A review on steel surface image features extraction and representation methods 2020 Lecture Notes of the Institute for Computer Sciences, Social-Informatics and Telecommunications Engineering, LNICST	10.1007/978-3-030-60036-5_17
	Universiti Putra Malaysia   International Islamic University Malaysia	



No.	TITLE/YEAR/AUTHORS	DOI
30	The influence of social media marketing on consumer purchase intention of fresh produce in Egypt 2020 Proceedings of the 7th European Conference on Social Media, ECSM 2020	10.34190/ESM.20.009
	Ragab, I.   Ragab, M.A.F.	
	Pharos University in Alexandria	
31	Comparison study for extraction of oil from oil shale 2020 Journal of Engineering and Applied Science	-
	Soliman, A.   Nassef, E.   Abu Alala, R.   Eltaweel, Y.	
	Alexandria University	
32	Evaluating the legibility of complex buildings: A quantitative model for indoor wayfinding 2020 WIT Transactions on Ecology and the Environment	10.2495/SC200121
	Ahmed, S.H.   Taha, D.S.   Hasan, A.E.	
	Alexandria University	
33	Predicting Stock Market Trends for Japanese Candlestick Using Cloud Model 2020 Advances in Intelligent Systems and Computing	10.1007/978-3-030-44289-7_59
	Madbouly, M.M.   Elkholy, M.   Gharib, Y.M.   Darwish, S.M.	
	Alexandria University	
34	Analysis of MHD slightly rarefied gas flow over a permeable stretching surface based on second-order velocity slip 2020 International Journal of Modern Physics C	10.1142/S0129183120501806
	El-Khatib, M.   Megahed, A.M.	
	Benha University	



No.	TITLE/YEAR/AUTHORS	DOI
35	Sustainable Touristic path toward cultural identity 2020 Journal of Engineering Research	10.21608/erj.2020.145854
	Ragheb, R.A.   Naguib, I.M.	
	Pharos University in Alexandria	
36	Raw gas oil production from waste plastic by vacuum pyrolysis 2020 Journal of Engineering and Applied Science	-
	Nassef, E.   Soliman, A.   Farag, H.A.   Eltaweel, Y.   Amer, A.A.	
	Alexandria University	
37	Specifying a program control path using flow diagram translated into description logic of ontology engineering 2020 ICIC Express Letters	10.24507/icicel.14.05.497
	Ibrahim, S.   Hassan, Y.F.   Kholief, M.H.	
	Arab Academy for Science, Technology and Maritime Transport   Alexandria University	
38	The effect of using baffles on the rate of mass transfer of a cylindrical stirred tank reactor 2020 Materials Science Forum	10.4028/www.scientific.net/MSF.1008.168
	Shokry, F.   El-Gayar, D.A.   Elfattah, M.A.   Farag, H.A.   Sedahmed, G.H.	
	Alexandria University	
39	Green HPTLC and stability-indicating RP-HPLC for the assay of dextromethorphan hydrobromide and menthol in their lozenges 2020 Annales Pharmaceutiques Francaises	10.1016/j.pharma.2020.04.006
	Ragab, M.A.A.   El Yazbi, F.A.   Hassan, E.M.   Khamis, E.F.   Hamdy, M.M.A.	
	Alexandria University	



## 12.4 – Courses in Curricula

No	Faculty in Pharos University	Course name	Course code	SDG of relevance	Topics in each course
1	Applied Health Sciences Technology	Development and Regulation of Medical Products	MGDR-101	SDG 12	Responsible consumption and production methods
2	Applied Health Sciences Technology	Ethical and Legal Issues in Health Fields	MGME-101	SDG 12	Wellbeing and living standards
3	Pharmacy	Environment and sustainability	PMC E01	SDG 12	Sustainable ecosystem services
4	Pharmacy	Project in Pharmacognosy & Natural Products	PG E08	SDG 12	Sustainable use of natural resources
5	Pharmacy	Good Manufacturing Practices	PPC E02	SDG 12	Responsible production consumption techniques in pharmaceutical industry
6	Pharmacy	Natural Cosmetics	PGD E01	SDG 12	Sustainable use of natural resources
7	Pharmacy	Herbal medicine	PGD E02	SDG 12	Sustainable use of natural resources
8	Pharmacy	Sustainability in Therapeutics	PLD E03	SDG 12	Sustainable use of natural resources
9	Tourism	Consumer Behavior in Tourism and Hospitality (Elective)	THM 162	SDG 12	Responsible consumption and production methods
10	Tourism	Current issues in food service (Elective)	HM 336	SDG 12	Healthy food for wellbeing, consumption reduction
11	Tourism	Safe Food Service Management	HM 434	SDG 12	Healthy food for wellbeing, consumption reduction





No	Faculty in Pharos University	Course name	Course code	SDG of relevance	Topics in each course
12	Engineering	Energy Systems	EE 271	SDG 12	Studying the availability of using PV arrays in residential & commercial areas
13	Engineering	Material science	EP 217	SDG 12	This course introduces the students to Classification of engineering materials, atomic and molecular structure. The course focuses on polymer properties and modification for special applications.
14	Engineering	Introduction to environmental engineering	EP 389	SDG 12	The course introduces engineering aspect with complete environmental assessments of the impacts
15	Business	Consumer behavior	BF 746	SDG 12	The course focuses on issues related to the behavior of consumption and production and means to rationalize consumption



## SDG 13 – Climate Action

### 13.1 – Activities

Third International Conference on New Trends in Sustainable Energy (ICNTSE-2021) online

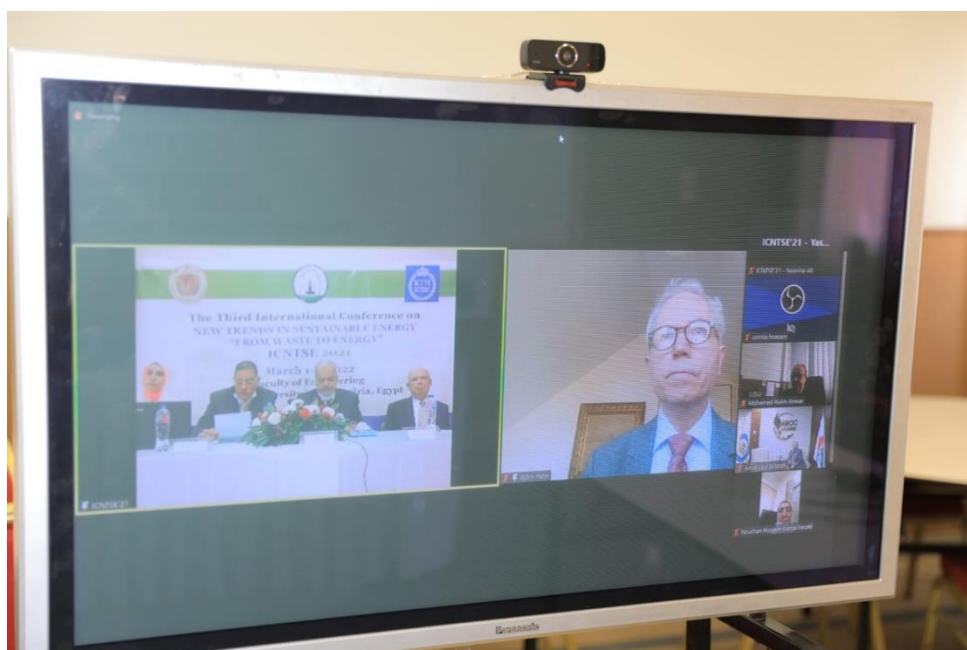



PUA's Faculty of Engineering organizes the Third International Conference on New Trends in Sustainable Energy (ICNTSE-2021) on 1-2 March 2022 via online conference. It is also worth mentioning that the Journal of King Saud University – Engineering Sciences (JKSUES) will publish a special edition for a selected group of the conference's researches, which meet the journal's publishing requirements.

<https://www.pua.edu.eg/third-international-conference-on-new-trends-in-sustainable-energy-ictse-2021-online/>

### Climate conference



A high-level delegation from Pharos University participated in the “Future of Alexandria and Climate Challenges” conference held at the Bibliotheca Alexandrina on Tuesday, March 29, 2022, which was co-sponsored by Pharos University. The delegation included Prof. Dr. Mahmoud Mohy El-Din, President



of the University, Prof. Dr. Prof. Nourhan Fanaky, Vice-President for Education and Student Affairs, Prof. Dr. Prof. Ramadan Abu El-Ala, Vice President of Community Service & Environment Development Affairs, Prof. Dr. Boshra Salem, Dean of Postgraduate Studies and Research, and Prof. Dr. Ramadan Abdel Maksoud, Supervisor of the Department of Architecture, Faculty of Engineering, along with a number of university students. Further, the delegation members participated in the important discussions and recommendations produced from the sessions held in this regard.

### Climate Conference

## Pharos University organized towards sustainable tomorrow competition



The faculty of Engineering organized the “Towards Sustainable Tomorrow” competition sponsored by Birla Carbon Egypt for the third year in a row. This was held on Tuesday, 28 July 2020. The competition aims to choose creative projects that serve sustainability. It is worth mentioning that 6 projects participated in this competition from Electrical Engineering, Mechanical Engineering, Petrochemical Engineering Departments. The judging panel was comprised of:

- Mona Gamal Eldeen, the Dean of the School of Energy Resources, Environment, Chemical and Petrochemical Engineering at the Egypt-Japan University of Science and Technology. (Head of the judging panel)



- Wael Almaghlany, the Head of Mechanical Engineering Department at Alexandria University.
- Boshra Salem, the Consultant of the President of the University for International Relations and Projects.
- Mohamed Naeem, the Vice Dean of the Faculty of Engineering.

The electrical engineering project “IoT Approach for Sustainable Green Campus” won the 2nd place in the competition. It was submitted under the supervision of Dr. Mohammed Adb El Karim.

Petrochemical Engineering Department participated with 2 projects:

- “Synthesis of Ion Exchange Resins for Ammonia Removal Based on Waste Polymers” which was submitted under the supervision of Dr. Rania Farouk.
- “Recycling of Polyester Fabric Scraps” won 3<sup>rd</sup> place in the competition. It was submitted under the supervision of Dr. Ehsan Nafed.

Mechanical Engineering Department participated with 3 projects:

- “Design, Modeling and Performance Analysis of Solar Still” which was submitted under the supervision of Dr. Mohamed El Saied Youssef.
- “Design and Optimization of Network Solar” won the 1<sup>st</sup> place in the competition. It was submitted under the supervision of Dr. Mohamed El Naqib.
- “Home Scale Vertical Axis Wind Turbine (VAWT)” won the 2nd place in the competition. It was submitted under the supervision of Dr. Sameh Tawfik.

[Pharos University Organized “Towards Sustainable Tomorrow” Competition](#)

**Lecture about Fuel Cells to the Petrochemical Engineering Department**





In light of the significant development the world has been witnessing recently in the development and production of hybrid and electric vehicles (HEV/EV) plus the recent developments in high voltage battery technologies due to its environmental advantages, the Petrochemical Engineering Department organized a lecture on fuel cells.

This lecture was held on Monday, May 23, 2022 and delivered by Prof. Dr. Alana Al-Sahrawi, the globally-renowned figure in the field of electric and hybrid cars in the United States of America. as part of the “Energy Conservation” course.

Further, the lecture – which was part of the “Energy Conservation” course – tackled the various technical aspects of future vehicle technologies and the extent to which fuel cells can be utilized in operating these vehicles. It also aimed at providing the graduates of the Petrochemical Engineering Department with the skills required for the labor market.

[Lecture about Fuel Cells to the Petrochemical Engineering Department](#)

## Sustainability Competition



Within the sustainability week launched by the Tourism Department, 3rd year students in the tourism impact and sustainability course – as part of their final dissertation – presented a set of creative ideas. These ideas reflected the concept of sustainability and its significance for tourist destinations. One of these ideas was about living a sustainable and climate-friendly life

The students were divided into a group of competing teams, under the supervision of Assoc. Prof. Dr. Ghada Bassiouni, and Prof. Amr Moroccan. Each team was keen on implementing an idea that reflects the concept of sustainability in tourist destinations.

This was done by designing posters, fliers, and magazines, that highlighted the extent to which they have acquired the learning skills targeted in the course specification.

<https://www.pua.edu.eg/sustainability-competition/>



### 13.2 – Courses in Curricula

No	Faculty in Pharos University	Course name	Course code	SDG of relevance	Topics in each course
1	Pharmacy	Environment and sustainability	PMC E01	SDG 13	Sustainable ecosystem services
2	Pharmacy	Phytotherapy	PG 305	SDG 13	Sustainable industry of Natural products
3	Tourism	Tourism Transportation	TM 312	SDG 13	Co2 and emission reduction
4	Engineering	Introduction to environmental engineering	EP 389	SDG 13	The course introduces engineering aspect with complete environmental assessments of the impacts
5	Engineering	Pollution control in petrochemical industries	EP 392	SDG 13	The course focuses on emissions from petrochemical industries and sustainable control mechanisms

## SDG 14 – Life Below Water

### 14.1 – Activities and Events

#### Pharos contributions in the “Live Green” Presidential initiative



Prof. Ramadan Abu El-Ala, the Vice President of Community Service and Environment Development Affairs and Prof. Hesham El Shimy, the Director of the Community Service and Environmental Development Centre (CSED) participated in a meeting about the “Live Green” initiative. The meeting was held in Alexandria Governorate Office. The meeting was attended by Mr. Ahmed Gamal, the Deputy Governor of Alexandria and representatives from all concerned authorities in the governorate.

This meeting aimed to discuss the mechanisms to apply the “Live Green” initiative launched by the President of Egypt to raise environmental awareness in Alexandria. During the meeting, Mr. Ahmed Gamal stressed the importance of the consultative role of Pharos University which came within the framework of the government keenness to achieve cooperation and integration by taking advantage of the experiences of the scientific bodies in Alexandria and working hand in hand for the benefit of the governorate.

In addition, Prof. Hesham El Shimy showed the attendees a study on “Harmonic Mechanisms for Treating all Types of Wastewater to Irrigate a Sustainable Green Belt to Protect the Vicinity of Lake Mariout.” It is worth mentioning that the study impressed all the attendees and it was stressed upon the need for adopting that study by the governorate and other authorities at the local and central levels. At the end, the Deputy Governor asked for an electronic copy of the study to put it into practice.





## Pharos Contributions in the “Live Green” Presidential Initiative

### Media and Climate Changes Seminar



As part of its interest in participating in important issues at both global and local levels, PUA’s Faculty of Mass Communication organized a seminar on “Media and Climate Change in the Light of the Sustainable Development Goals”. This seminar tackled the following topics:

- Climate changes and how to adapt to them.
- Urgent actions to address climate changes.
- Alexandria and the fate of disappearance.





- Rising temperatures and their impact on coastal cities.
- Sustainable development and climate fluctuations.
- The role of media and social media in educating the public about climate changes and their effects on all aspects of life.

The seminar aimed to educate students about the climate change crisis and its effects on the future of upcoming generations.

<https://www.pua.edu.eg/media-and-climate-changes-seminar/>

### Fedalos Anay film

The Faculty of Mass Communication produces a short film on a film on Ecotourism and the culture and heritage of villages in Upper Egypt. This film is called (Fedalos Anay) or (We Welcome You). The film addresses the life of these small villages that were droned under water before and currently these villages are saved and sustainable. The film also covers the traditional knowledge particularly for women and its role in day life. All infrastructure is retained and sustained.

<https://www.youtube.com/watch?v=D6HwJvQK-Uk&list=PLsZ1HNiwxSAPBp9Ff74mHK1NbRVLCp-52&index=12>



## 14.2 – Publications

No	TITLE/YEAR/AUTHORS	DOI
1	Oil spill clean-up using combined sorbents: a comparative investigation and design aspects 2020 International Journal of Environmental Analytical Chemistry	10.1080/03067319.2019.1636976
	Tayeb, A.M.   Farouq, R.   Mohamed, O.A.   Tony, M.A.	
	Menoufia University   Pharos University in Alexandria   Minia University   Port Said University	
2	Novel sea water desalination unit utilizing solar energy heating system 2020 Alexandria Engineering Journal	10.1016/j.aej.2020.03.019
	ElHelw, M.   El-Maghlany, W.M.   El-Ashmawy, W.M.	
	Pharos University in Alexandria   Alexandria University	
3	Physico chemical studies for water at Rosetta Branch of River Nile, Egypt 2020 IOP Conference Series: Materials Science and Engineering	10.1088/1757-899X/975/1/012010
	Masoud, M.S.   Ismail, A.M.   Kamel, H.M.   El-Kholany, A.S.   ElKasas, A.A.M.	
	Pharos University in Alexandria   Alexandria University	



## SDG 15 – Life on Land

Sixty of the world's ecosystem services have been degraded over the past 50 years and we continue devaluing our natural resources at an alarming rate. While many of the effects are felt locally first, the long-term consequences are global and the scale is highly relevant to business, presenting risks and opportunities. To retain the integrity and vitality of natural resources today and for future generations and to ensure long-term socio-economic growth, sustainable management of land is key.

### 15.1 – Activities

#### 1. A sustainable and healthy tent for pilgrims



The Saudi office INJ Architects, in cooperation with UNI Competitions, launched an International Architectural Competition entitled: “**The White Lands**”, in which a large group of architectural offices, architects and architectural students have participated from 23 different countries around the world.

In the framework of the summer training 2020-2021, the Department of Architectural Engineering participated with a group of students from the **Fourth Level (8th Semester)**: **Aisha Mohamed, Nadine Hisham** and **Sarah Al Murabai**, under the supervision of **Associate Prof. Riham Nady Faragallah** and the team won the **First Prize** (People and Jurors Choice Award).



The main aim of the competition is to design a **sustainable and healthy environment that meets all the needs of pilgrims** through functional design of small spaces and upgrading their experience in the light of the increasing number of pilgrims in the city of Mina, Saudi Arabia. It takes into account the precautionary and hygienic measures to confront COVID-19, as well as applying various environmental treatments that are compatible with this desert area. In this way, the tents in the city of Mina are ready for the growth of pilgrims in the future.

The jury commented that it is good concept with reference to the “Tent” legacy of Mina, allowing for future growth and challenges of any health threatening issues (like the current COVID-19) with good health, hygiene and distancing measures.

### [A sustainable and healthy Tent for pilgrims](#)

#### 2. Devetsia short film

The faculty of mass communication produces a short film on a film called (Devetsia) demonstrating the environmental resources on land, water resources, desert ecosystem services regarding natural health treatments, and ecotourism in sustainable cities

<https://www.youtube.com/watch?v=sQrc2ufKFC4&list=PLsZ1HNiwxSAPBp9Ff74mHK1NbRVLCp-52&index=3>

#### 3. Recycling Fabric Wastes and Scraps to Achieve Sustainability Workshop





As part of PUA’s student activities program, the Faculty of Arts and Design organized a workshop entitled “Recycling Fabric Wastes and Scraps to Achieve Sustainability.” This workshop was prepared by Dr. Marwa Issa, Lecturer in the Fashion Design Department.

Despite the increasing attention to environmental issues and conservation, fabric scraps are still being wasted throughout the various stages of design and execution. Till today, the surplus in fabric scraps has no clear mechanism to utilize it.

Therefore, this workshop presents a new vision for utilizing the remnants of fabric waste and scraps. This can be done through merging the various patterns of the fabrics with basic materials, auxiliary materials, while observing compatibility.

<https://www.pua.edu.eg/recycling-fabric-wastes-and-scraps-to-achieve-sustainability-workshop/>

## 15.2 – Courses in Curricula

Pharos university is keen to integrate the topic of life on land, the conservation of natural resources and wild life protection to undergraduate students. The following courses are addressing such topics to undergraduates in 3 faculties

Faculty	Course name	Course code	SDG-relevancy	Topic
Pharmacy	Environment and sustainability	PMC E01	SDG 15	Sustainable ecosystem services
Pharmacy	Phytotherapy	PG 305	SDG 15	Sustainable industry of natural products
Tourism	Ecotourism	TM 371	SDG 15	Protection of wildlife
Tourism	Tourism impact and sustainability	TM 354	SDG 15	Conservation and protected areas management
Arts and design	Perception of the visual Environment	G331	SDG 15	Effect of nature on art and artists





## SDG 16 – Peace, Justice, and Strong Institutions

Promote peaceful and inclusive societies for sustainable development, provide access to justice for all and build effective, accountable, and inclusive institutions at all levels

Pharos University has records contributing to SDG16 in several aspects including conferences and seminars. Below is a summary of Pharos University achievements in SDG 16.

### 16.1 Seminars, Conferences and Workshops

- The faculty of Legal Studies at Pharos university (P.U.A) organized a seminar titled “Protecting the intellectual and data rights” and that on Tuesday 28/12/2021 in presence of Dr./ Mohammed Hagazy the manager of the office of protecting intellectual rights at council of the ministers and the communication minister and Prof./ Hamam Zahran Dean of the faculty of Legal Studies, a number of teaching committee and teaching assistants staff and a large group of students from different grades.

<https://www.pua.edu.eg/faculty-of-legal-studies-organized-a-seminar-titled-protecting-of-intellectual-and-data-right/>



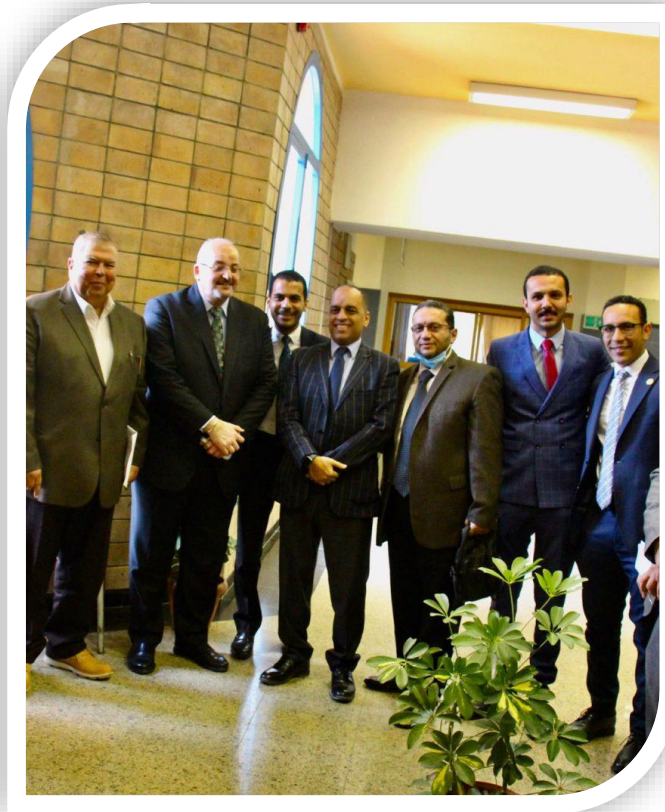

- PUA's Faculty of Pharmacy is distinguished with possessing a Scientific Research Ethics Committee. This committee is accredited by the Egyptian Network of Research Ethics Committees (ENREC) and affiliated to the Middle East Research Ethics Training Initiative (MERETI). This committee seeks to assist faculty researchers in publishing their papers in the most prestigious international journals. To accept the research by the Scientific Research Ethics Committee, many of these journals require a serial number from the institution where the research was conducted. It is a prerequisite for publication in many international scientific journals. Further, one of the tasks of the committee is to study what is referred to it to study the methodology proposed by the research team in accordance with the standards of scientific research ethics. Also, to establish by-laws for animal research and ethics in parallel with the internationally applied rules. The proposed methodology can be then given or not in terms of ethical approval. Further, the committee raises the awareness of the ethics of biomedical research.



<https://www.pua.edu.eg/faculty-of-pharmacys-scientific-research-ethics-committee/>

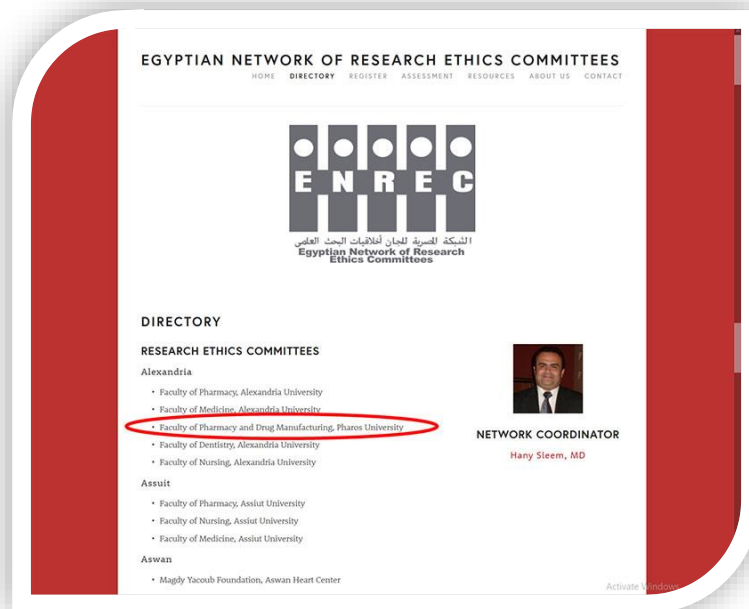

## 16.2 Related Manuscripts

- Multi-criteria decision making of sustainable adaptive reuse of heritage buildings based on the A'WOT analysis: A case study of cordahi complex, Alexandria, Egypt 2021 Ragheb, G.A. International Journal of Sustainable Development and Planning. DOI: 10.18280/IJSDP.160309
- Efficient Security Model for RDF Files Used in IoT Applications 2021 El kholy, M. | Mohamed, A.B. International Journal of Advanced Computer Science and Applications. DOI: 10.14569/IJACSA.2021.0120431.



### 16.3 Courses in Curricula

Faculty	Course name	Course code	SDG	Description
Tourism	Ethics and Human Rights	GEN 103	SDG 16	Wellbeing and living standards
Tourism	Legal Issues in Tourism and Hospitality	THM 245	SDG 16	Tourism sustainability and legalities
Law	Property and Real Rights Law	LV 07	SDG 16	Justice concepts and human rights
Law	Labor and social security law	LV 06	SDG 16	Social security issues and reduces inequalities
Business	Islamic finance and sustainability	BF858	SDG 16	The course describes the sustainability of Financing rules in Islam.

### 16.4 International Cooperation

Faculty	International Institute	Contributing SDG
Humanities (Law)	Sciences Po Lille - France	SDG 16



## 16.5 Publications

No	TITLE/YEAR/AUTHORS	DOI
1	Multi-criteria decision making of sustainable adaptive reuse of heritage buildings based on the A'WOT analysis: A case study of cordahi complex, Alexandria, Egypt 2021 Ragheb, G.A. International Journal of Sustainable Development and Planning	10.18280/IJSDP.160309
	Ragheb, G.A.	
	Pharos University in Alexandria	
2	Heritage-led urban regeneration: the case of "El-Shalalat District", Alexandria 2021 Abdelhamid, M.M.   El Hakeh, A.H.   Elfakharany, M.M. Journal of Cultural Heritage Management and Sustainable Development	10.1108/JCHMSD-05-2021-0098
	Abdelhamid, M.M.   El Hakeh, A.H.   Elfakharany, M.M.	
	Arab Academy for Science, Technology and Maritime Transport   Pharos University in Alexandria   Technische Universität Darmstadt	





## SDG 17 – Partnerships for the Goals

### 17.1 – National Cooperation for Implementation of SDGs

List of Ministries and National Directorates in the health sector that Pharos University cooperated with for implementing Students' community projects.

Alexandria Governorate	Conferences and meetings
Institute of Cultural Affairs	Students Projects
Education Directorate – Alexandria Governorate, Ministry of education	Community service projects
Education Directorate – Beheria Governorate, Ministry of education	Community service projects
Health Directorate – Ministry of Health	Community service projects
Cairo University	Research
Alexandria University	Research
Al Azhar University	Research Project
Menia University	Research Project
Academy of Science and Technology	Research Project
High Institute of Public Health	Research Project
Ministry of Health	COVID Vaccination
Arab Organization for Industrialization	Scientific research and training
Red crescent and blood bank	Students Projects
Alexandria Mineral Oils Company (AMOC)	Partnership
Petroleum Products Company (ASPPC)	Partnership and training



Below is the List of NGOs that Pharos University Cooperates with for Community Service Projects

Egyptian Network for Research Ethics Committees	Research Project
Naba'a Al Hayat Foundation	Community service projects
Mojeeb Al Salayen Foundation	Community service projects
Al Staqrar Foundation	Community service projects
Kafalat Al Yateem Foundation at Fata neighborhood	Community service projects
Al Qalaa for Community Development.	Community service projects
Eleen ElGaria association	Community service projects
Abdel Kadr Association	Community service projects
Tarek Charity Association (Mustafa Kamel)	Community service projects
Abu Masoud Suburb (Amiria)	Community service projects
Ayadi Mostakbal medical center (NGO)	Training
Omda Development Association (NGO)	Students Projects
Association of community based rehabilitation for disabled children (NGO)	Students Projects
Red Crescent Association (Mohandeseen)	Community service projects
Tarek ElKhair	Community service projects
Al mutadarieun	Community service projects
El Qalaa	Community service projects
Kfalet El Yatem	Community service projects
Nabaa El Hop	Community service projects
El Estqrar	Community service projects
Birla Carbon Egypt	Student research project



## Cooperation with the Private sector

The private sector is an important sector that Pharos university is keen to cooperate with for different purposes, mainly for meetings, conferences, and workshops. Such meetings allow the recognition of new trends in the local and regional market and allow meeting the market needs. Below is the List of private sectors That Pharos University Cooperates with

Company name	Type of cooperation
Eva Pharma	Participation in Conference
Innova Pharma	Participation in Conference
Hygint Pharmaceutical company Ltd.	Participation in Conference
Goweily Academy	Workshops
Andalusia Hospital (Private Hospital)	Students activities
El Yousr Hospital (private Hospital)	Students Projects
Fawzy Moaaz Hospital (Private Hospital)	Students Projects
Carrefour	Partnership
Easy Care Company	Partnership
Mena For Touristic and Real Estate Development	Partnership
IdeaSpace	Student training
Capital Professional Development	Student training
the Industrial Modernization Centre (IMC)	Partnership and training



## 17.2 – Cooperation For SDG 1

### 17.2.1 PUA celebrated Orphans Day with charity NGOs

PUA celebrated Orphans Day. The coordination was made between the Community Services and Environment Development Affairs and six charities NGOs:

- “Tarek ElKhair” Community Service, Sidi Gaber.
- “Al mutadarieun” Community Service, Rabaa El Nasria, Abis.
- “El Qalaa” Community Service, Awayed.
- “Kfalet El Yatem” Community Service, Ezbet Fathi.
- Nabaa El Hop” Community Service, El Hadra El Gadida.
- “El Estqrar” Community Service, Zawya Abd El-Qader, Al Amaria.



The ceremony was held at those charities. On 9th and 10th of April 2021, PUA formed six groups comprised of students, faculty members and coordinators of the student activities to visit those charities and give the orphans toys, gifts and clothes that had a good impact on children and staff. This activity is a part of the university’s keenness to activate its role in developing the spiritual, moral and loyalty values of students as well as participating in community service.

### 17.2.2 Coordination with the Ministry of Social Solidarity and Alexandria Governorate [Humanitarian Aid Convoy to Abees District in Alexandria](#)

In coordination with the Ministry of Social Solidarity and Alexandria Governorate. It is worth mentioning that many students from different faculties participated in this convoy. Prof. Hesham El Shimy, the Student Activities Leader and Prof. Ramadan Abo El Ala, the PUA Vice President. Moreover, Dr. Jackline Azar, the Deputy Governor of Alexandria was keen to participate and follow up the proceedings of this convoy where she expressed her admiration for the university’s activities in the field of community service and the students’ behavior.





<https://www.pua.edu.eg/pharos-university-sent-a-humanitarian-aid-convoy-to-abees-district-in-alexandria/>

## 17.3 – Cooperation For SDG 3

### 17.3.1 Cooperation with the Ministry of Health in the vaccination to combat Covid 19

The Egyptian government has made COVID-19 vaccination compulsory for students above the age of 18, faculty staff and other workers at both public and private universities. Egyptian-made Chinese Sinovac shots will be supplied to vaccination centers at university hospitals to vaccinate university workers, students, and higher education staff before the beginning of the next academic year, in October. Each institute and research center will also establish its own vaccination clinic.

### 17.3.2 Vaccination activities in Pharos University

Pharos University has put a plan for vaccination against Covid 19 of students and staff members, as well and community nearby the university premises.

The plan started on September 2<sup>nd</sup> 2021, where 2500 dose pf Sinovac were received associated with special 0,5 cc sterile syringes. Each dose received is enough for two persons which makes these amounts sufficient to vaccinate 5000 persons.

The target number of persons to be vaccinated at the university for the local community is 14500 during the whole month of September with average daily dosages of about 232 recipients.

The vaccination work was extended till the middle of October to meet the targeted number and receiving more doses of vaccine that would be sufficient for all.

Vaccinating all members of the university community would improve the chances for a return to face-to-face educational activities.

However, returning to in-person education should not mean heading back to a hybrid education system. A new system “should continue on building” digital education, while adding the benefits of face-to-face activities





Waiting  
Hall



Reporting  
and check  
ups



Vaccination





### 17.3.3 The Faculty of Arts and Media Blood Donation Campaign

The Faculty of Arts and Media in collaboration with the Faculties of Legal Studies, Engineering, Pharmacy and Dentistry organized a blood donation campaign on Tuesday, March 15th, 2022. The event was organized within the framework of PUA's participation in community service activities. The event started at 11 am with the arrival of a blood donation vehicle from the Blood Bank. The campaign was met with an overwhelming turnout of students, while the faculties cooperated in organization and motivation of the students.

<https://www.pua.edu.eg/%d9%83%d9%84%d9%8a%d8%a9-%d8%a7%d9%84%d9%81%d9%86%d9%88%d9%86-%d9%88%d8%a7%d9%84%d8%aa%d8%b5%d9%85%d9%8a%d9%85-%d8%aa%d9%86%d8%b8%d9%85-%d8%ad%d9%85%d9%84%d8%a9-%d9%84%d9%84%d8%aa%d8%a8%d8%b1%d8%b9/>



### 17.3.4 Governmental and Private Hospitals

List of governmental and Private hospitals in Alexandria and Beheria Governorates that cooperated with Pharos University for students' training and internships

Hospital Name	Purpose
Armed Forces Hospital- Mustafa Kamel	Internships
International cardiac center ICC	Training and Internships
General Military Hospital	Internships
Faculty of Medicine Hospital of Alexandria University	Training and research
Andlusia Hospital	Training
NAPHS	Online Training
57375 Hostital	Students' activities

### 17.3.5 Students Projects

#### “Factors affecting COVID-19-related health literacy in Egyptian population”

The aim of this project is to assess coronavirus-related health literacy in Egyptian population and to increase their awareness about preventing the spread of COVID-19 virus.

- Specific Objectives
  - A. Measure Patient's health literacy regarding the disease
  - B. Examine the differences in health literacy in relation to age, gender, education level, professional background being medical or non-medical, and socioeconomic factors.
  - C. Provide evidence-based information to the enrolled participants about the protective measures required to stop the spread of the COVID-19 virus and answer their enquiries about this topic.



### Subjects and methods:

This cross-sectional study was done in Egypt during the second wave of COVID-19 pandemic. It represents a population-based survey on comprehensive health literacy in relation to coronavirus information and it uses the adapted HLS-EU-Q in the context of the COVID-19 to assess coronavirus-related health literacy. It also tests COVID-19-related health literacy in individuals in relation to feeling informed or confused about COVID-19 by the high flow of information about the COVID-19. Each item of the questionnaire was rated on a four-point Likert scale (very difficult, difficult, easy, and very easy). “Very difficult” was scored as 1 “difficult” was scored as 2, “easy” was scored as 3, and “very easy” was scored as 4. Scale values were calculated as summed scores.

#### 1) Sociodemographic Questions:

Participants were asked about their gender, age, education, household monthly income, and occupation (medical versus non-medical background).

#### 2) Information or Confusion about the Coronavirus

#### 3) Health Literacy assessment

- Mean score of <2.5: “inadequate health literacy”
- Mean score of 2.5–3: “problematic health literacy”
- Mean score of >3: “sufficient health literacy”

4) Questionnaire tools was translated from English into Arabic by an independent Arabic native speaker, and later back translated by a second translator to establish a version (semantically, conceptually, and experientially) equivalent to the original one. The retro-translation gave rise to no differences.

### Second phase: Questionnaire filling

The survey was done via participants interviews in spring 2020-2021. Students were divided into groups for questionnaire sample collection using stratified random sampling technique. They were divided according to the criteria of participants enrollment into 16 groups that represent the diverse Egyptian population, where each student applied face-to-face interviews with 10 participants. The survey included male and female participants from Egypt. Each student filled the gathered information later in a Google form.



Third phase: Increasing population awareness about COVID-19 pandemic

Fourth phase: Statistical analysis:

Ethical approval:

Ethical approval was granted by the ethics committee of the faculty of pharmacy, Pharos university in Alexandria, Egypt (Study number: PUA01202106203024

### **Conclusion:**

There is a great need to promote health education among the Egyptian population. Limited health literacy which includes problematic and inadequate health literacy is a common problem. More than half of the Egyptian population has inadequate or problematic COVID-19 related health literacy score. Female gender, younger age, higher socioeconomic status, professions with medical background, and level of education were positively correlated to COVID-19 related health literacy. It is important that the government, policymakers, healthcare providers, and media act proactively to increase the level of the citizens COVID-19 related health literacy.

### **“The Baby Safe mattress”**

The Baby Safe mattress. It is a medical mattress for children, the purpose of which is to protect the child from any emergency situation, whether it is an increase in the child’s temperature, an irregular heartbeat, or a decrease in the level of oxygen in the blood through sensors located in the mattress. It issues alerts to the mother through a loudspeaker or through the mother or father’s phone by downloading a special program for the mattress to inform them periodically about the health of their child.

### **Aim of the Research Project (baby safe):**

**One of the goals of serving working women and providing family safety is that the research project aims to** provide comfort for the mother and father and safety for the child by following up on his health status during sleep or waking up and making sure that the child’s condition is safe through the sensors in the rank that constantly send updates on the child’s condition. The application is available on the parents’ phones, and if an error occurs in the child’s pulse, oxygen, or temperature, alerts are sent to the mother or father’s phone to inform them of the location of the defect.

### **Stages of Carrying out the Research Project (baby safe): -**

1-After suggesting the idea among the work team members





2- It was implemented in a maquette that expresses and about the sensors and the sounds of alerts that come out of it to warn about something that is happening

3- A website has been created for the product to be sold on the Internet

4- Create pages on social networking sites (Facebook and Instagram) to promote the product and explain it to the consumer

5- Proposing sales development plans for the product, for example: by making contracts with outlets selling children's products to display our product in their showrooms

### **(Implementing “Dental Traumatic Injuries Educational Program” Among teachers at different Governmental Elementary schools in Alexandria, Egypt.)**

#### **The aim of this study was to:**

- Assess the level of knowledge of the governmental elementary school teachers about TDIs & their management, using questionnaires.
- Awareness about TDIs emergency management through implementing an oral health educational program to the same target group.
- Traumatic Dental Injuries (TDIs) are a serious dental public health problem among children (International Society of Preventive & Community Dentistry, 2019). It can vary from a minor tooth fracture to extensive maxillofacial damage. Oral injuries are the fourth most common area of bodily injuries.
- The prevalence of Traumatic injuries in permanent teeth have been reported to exceed 60%. In Egypt, a study was conducted by ElKelany M. et al concluded that the most common areas of TDIs among children were at school (50%) then at home (30%); this was mostly due to increased predisposition of accidents, fights & sports traumas at school age.

#### **❖ Recommendations:**

- We recommend implementing a dental traumas awareness program at different schools in Alexandria.
- Also, to provide an emergency dental unit at PUA outpatient clinics (PUA trauma center); furthermore, establishment of trauma hotline to provide teachers with appropriate management in case of TDIs emergency.



## Assessment and Intervention Program to Raise Nutritional and Health Awareness of Females in the Reproductive Age and their children in Alexandria Rural Area "Houd 10"

### ❖ Project Aim:

- To assess the nutrition status and awareness of rural women.
- To assess the nutritional knowledge and the awareness of rural women.
- To conduct nutrition education program to raise the awareness of the rural women in the target areas.
- To evaluate the nutritional knowledge and the awareness after intervention program.

### ❖ Project Summary:

- Project Idea: Assessment of nutrition status of rural women to tackle any nutritional problems and evaluation of their nutritional knowledge aiming at providing targeted educational sessions to raise their awareness and improve their nutritional knowledge.
- Project Phases: The project was carried out in three phases

### Phase I:

1. Designing a questionnaire to measure the nutritional knowledge and awareness of rural women in Houd 10
2. Taking the approval from stakeholders (CAPMAS, Ministry of social solidarity, and National Security agency)

### Phase II:

- Collection of data (interviewing of the women, anthropometric measurements, and laboratory investigations)

### Phase III:

- Designing and implementing educational programs through conducting awareness seminars in Houd 10 (rural area) through illustrative posters and lectures
- Recollecting data through post-intervention questionnaire to assess the changes in the nutrition knowledge of the rural women



## 17.4 – Cooperation For SDG 4

### 17.4.1 PUA signed a cooperation protocol with IdeaSpace for students training

<https://www.pua.edu.eg/pua-and-ideaspace-sign-a-cooperation-protocol/>

In implementation of its field training plan, PUA signed a cooperation protocol with IdeaSpace Company, which represents the “Egypt Makes Electronics” initiative (EME) of the Information the Information Technology Industry Development Agency (ITIDA) to train PUA’s students.

### 17.4.2 Pharos university participates in “Egypt Make Electronics” initiative (EME)

<https://www.pua.edu.eg/education-development/>

In recognition of the Faculty Applied Health Sciences Technology and the Department of Biomedical Equipment Technology of the necessity of developing education through linking the academic activities with the Egyptian industrial initiatives.

Based on coordination made by Asst. Prof. Dr. Mohamed Ismail Badawy, Head of the Department of Biomedical Devices Technology; *and*

In response to the invitation extended by “Egypt Make Electronics” initiative (EME), which is funded by the Information Technology Industry Development Agency (ITEDA), of the Ministry of Communications,

17 Department students along with five faculty members and teaching assistants visited EME’s Innovation Hub-Borg Al Arab. The visit aimed to identify the possibilities available, and to open horizons for the Department students to implement their graduation projects.



As a result, the students learned about the initiative’s capabilities and its advanced laboratories, such as printed circuit laboratories, manufacturing



laboratories, artificial intelligence laboratories, and Internet of Things laboratories.

### 17.4.3 Cooperation protocol with Capital Professional Development for training of the students of the faculty of Languages and Translation

<https://www.pua.edu.eg/pharos-university-signed-a-cooperation-protocol-with-capital-professional-development/>

In the light of the field training plan set for the faculty of Languages and Translation, Pharos University signed a cooperation protocol with Capital Professional Development on Monday, 1 February 2021. It is worth mentioning that the protocol aims to train the students of the faculty of Languages and Translation.

It has been agreed upon training almost 100 students in 6 days in the following topics: Human Resources, Customer Service and Marketing. The students will be evaluated on group projects after each training topic and they will receive certificates after finishing the field training course.

### 17.4.4 A visit to Ayady ElMostakabal Foundation

Ayady ElMostakabal is NGO aiming at helping Children diagnosed with cancer, Pharos university is in active partnership with the organization and support their activities via donations and other means of cooperation





List of governmental and Private Companies that cooperated with Pharos University for t students’ training and internships

Egyptian Projects Operation & Maintenance   EPROM	Faculty of Engineering
Alexnadria company for electricity	Faculty of Engineering
Egyptian Ethylene and Derivatives Company (ETHYDCO)	Faculty of Engineering
Mosahamet El Behera	Faculty of Engineering
ETM. Agricultural Service	Faculty of Engineering
SEDlkrirl for petrochemicals SEDPEC	Faculty of Engineering
WE, ELmasryaa for communications	Faculty of Engineering
Arab African company	Faculty of Engineering
XYPEX	Faculty of Engineering
RUNPeoff LLC	Faculty of Engineering
DI GI print	Art and designs
Alex Apparels	Art and designs
Monarch Materials	Art and designs
Attorneys syndicate	Legal Studies and international cooperation
Elzahraa language school	Languages and translations
Capital professional development	Languages and translations
HSH Education company	Languages and translations
EG Bank	Financial and administrative science
Knowledge officer company	Financial and administrative science

## 17.5 – Cooperation For SDG 6

### 17.5.1 Pharos university Contributions in the “Live Green” Presidential Initiative

<https://www.pua.edu.eg/pharos-contributions-in-the-live-green-presidential-initiative/>

The Vice President of Community Service and Environment Development Affairs and the Director of the Community Service and Environmental Development Centre (CSED) participated in a meeting about the “Live Green” initiative. The meeting was held in Alexandria Governorate Office on Wednesday, 12 February 2020.

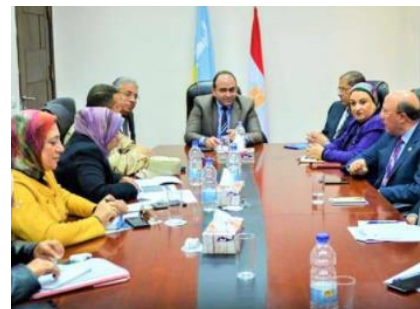

The aim of the meeting is to discuss the mechanisms to apply the “Live Green” initiative launched by the President of Egypt.





<https://english.ahram.org.eg/NewsContent/1/64/362323/Egypt/Politics-/Egypts-Live-Green-initiative-reflects-the-states-c.aspx>

The meeting was attended by the Deputy Governor of Alexandria and representatives from all concerned authorities in the governorate. During the meeting, Mr. Ahmed Gamal stressed the importance of the consultative role of Pharos University which came within the framework of the government keenness to achieve cooperation and integration by taking advantage of the experiences of the scientific bodies in Alexandria and working hand in hand for the benefit of the governorate.

In addition, Prof. Hesham El Shimy showed the attendees a study on “Harmonic Mechanisms for Treating all Types of Wastewaters to Irrigate a Sustainable Green Belt to Protect the Vicinity of Lake Mariout.” It is worth mentioning that the study impressed all the attendees, and it was stressed upon the need for adopting that study.

## 17.6 – Cooperation For SDG 7

### 17.6.1 Production of Biojet fuel a project in line with the sustainable development goals and Egypt 2030

The Petrochemicals Department at the Faculty of Engineering carried out a study aiming at designing a reactor for the production of biofuel using hydrodynamic cavitation technique. This technique is based on intensifying the rate of the reaction and the production of biofuels from non-edible oil by introducing bubbles to the liquid. A model was constructed to t explains this process and validate

it using experimental data. The reactor has already been implemented successfully and experiments have been conducted to test to prove its effectiveness. This clean biofuel is considered as an alternative to fossil fuel used in industry, in aviation in addition to avoiding the negative impacts of fossil fuel combustion.

The production of an alternate source such as bio jet fuel can be a viable sustainable option, based on non-edible oils, and in line with the sustainable development goals and Egypt 2030. The development of bio jet fuel from renewable sources would not only reduce the reliance on fossil fuels, but also can potentially reduce CO<sub>2</sub> emissions by up to 68.1% in 2050. Hydrodynamic cavitation can be effectively used for the intensification of interesterification reaction for the synthesis of bio jet fuel and glycerol.

NO.	DESCRIPTION	NO.	DESCRIPTION	NO.	DESCRIPTION
01	BIO FUEL	06	MECHANICAL STAINLESS STEEL SHAFT	11	TRANSPARENT STATOR
02	SEPARATION HOPPER	07	HIGH SPEED BEARING	12	EM THREADED BOLT WITH NUTS
03	GLYCERIN	08	SAMPLING POINT	13	PERISTALTIC PUMP
04	ELECTRIC MOTOR (3000 RPM)	09	GATE VALVE (ISOLATION)	14	FLANGE
05	FLEXIBLE SHAFT COUPLING	10	CYLINDRICAL ABSORBOR	15	MAGNETIC STIRRER

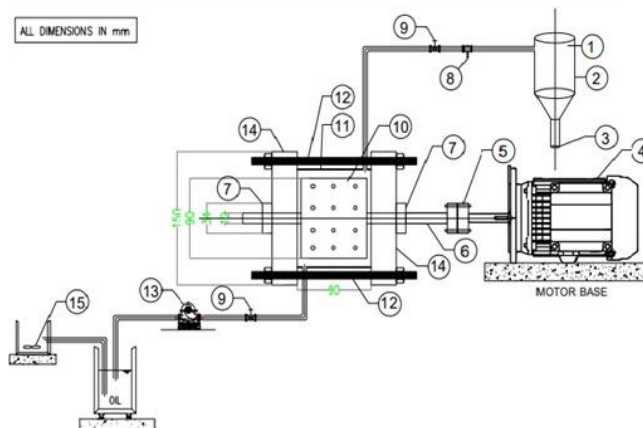

## 17.7 – Cooperation For SDG 8

### 17.7.1 Fifth job fair of the Faculty of Tourism and Hotel Management

Prof. Dr. Mahmoud Mohy El-din, PUA's President, launched the Fifth job fair, which was organized by the Faculty of Tourism and Hotel Management.

This fair comes within PUA's endeavor to provide job opportunities for its graduates, and to implement training partnerships with various tourism companies and hotel chains in Alexandria.

The fair witnessed a large presence of industry men and Faculty's cooperation partners, represented by 20 tourism companies and hotels. As well as representatives of the Ministry of Tourism and the Tourism Promotion Authority in Alexandria.

Accordingly, the Faculty administration extends its sincere thanks and appreciation to all those who thankfully participated in the job fair. As well as for the support provided to promote the level of training in the faculty and facilitating the graduates' access to proper job opportunities.





## 17.8 – Cooperation For SDG 9

### 17.8.1 Cooperation with industrial Modernization Centre (IMC) in providing solutions to some of the problems encountered by the industrial sector in Alexandria

<https://www.pua.edu.eg/pharos-university-to-foster-ties-with-the-industrial-modernization-centre/>

Prof. Ramadan Abu El-Ala, the Vice President of Community Service and Environment Development Affairs, along with Prof. Hana Yassin, the Dean of the Faculty of Arts and Design- Pharos University held a meeting with some representatives of both branches of the Industrial Modernization Centre (IMC) in Cairo and Alexandria. During the meeting, means of cooperation were sought between Pharos University on one side and the Industrial Modernization Centre (IMC) and the whole industrial sector in Alexandria on the other side, in concern with the realm of field training as well as the implementation of the students' graduation projects. It was also discussed the possibility of the participation of Pharos University in providing solutions to some of the problems encountered by the industrial sector in Alexandria. At the end of the meeting, Prof. Ramadan Abo El-Ala called for another meeting between Pharos University and the Industrial Modernization Centre (IMC) to work on achieving the goals of the community service sector in Pharos University and finding solutions for the problems of the industrial sector in Alexandria.

### 17.8.2 Cooperation Protocol between Pharos University and Arab Organization for Industrialization

<https://www.pua.edu.eg/cooperation-protocol-between-pharos-university-and-arab-organization-for-industrialization/>

The protocol included the possibilities of joint cooperation in the fields of scientific research, training and participation in solving technical problems for the sake of carrying out research and patents and benefiting from the scientific and human capabilities at Pharos university and the Arab Organization for Industrialization. The delegation was received by Prof. / Mahmoud Mohy Al-Din – President of the University, Prof. / Ramadan Abu Al-Ela – Vice President for Community Service and Environmental Development Affairs, Prof. / Mohammed Gabar Abo Ali Faculty of Engineering Dean, Prof. / Mohammed Naem Faculty of



Engineering Vice Dean, and Prof./ Mohammed Yahia Al-Makki Professor at the Faculty of Engineering, and several teaching staff committee at the faculty. Both parties agreed on the optimal use of the resources to move to the rank of developed countries and achieving the developmental desired aims of the Egyptian society and to accomplish the above the both parties signed a cooperation protocol signed by Prof./ Mahmoud Mohy El-Din as a Pharos University President Also Major General/ Ahmed Abdel Aziz – authorized by Lieutenant General chairman of the organization.

### **[17.8.3 Protocol on Cooperation Between PUA and Alexandria Mineral Oils Company \(AMOC\)](#)**

<https://www.pua.edu.eg/protocol-on-cooperation-between-pua-and-alexandria-mineral-oils-company-amoc/>

The meeting and the signed protocol have tackled the prospects of mutual cooperation in training fields, and participation in solving the technical issues, to which PUA can contribute in finding practical solutions. Accordingly, both parties have agreed on making optimal use of their respective capabilities in a manner compliant with the state's strategy in terms of connecting industrial institutions and productions sites, with the Egyptian Scientific and Academic Institutions to achieve the developmental objectives of the Egyptian society. To achieve that, a protocol on cooperation has been signed by Prof. Dr. Ramadan Abu Al Ella, as PUA's Vice-president for Community Services and Environment Development and Chem. Ehab Ahmed Abdul Halim, as Chairman and Managing Director of Alexandria Mineral Oils Company (AMOC).

### **[17.8.4 PUA Signs a Protocol on Cooperation with Alexandria Specialty Petroleum Products Company \(ASPPC\)](#)**

<https://www.pua.edu.eg/pua-signs-a-protocol-on-cooperation-with-alexandria-specialty-petroleum-products-company-asppc/>

A high-ranking delegation of Alexandria Specialty Petroleum Products Company (ASPPC) visited PUA. The delegation was headed by Chem. Dr. Mosaad Attia Al Qasabi, Chairman and Managing Director. The delegation was hosted by Prof. Ramadan Abu El-Ala, Vice President of Community Service & Environment Development Affairs, Prof. Dr. Prof. Mohamed Gaber Abou Ali, Dean of the Faculty of Engineering, Prof. Dr. Gamal Elbhery, Dean of the Faculty of Computer





Science & Artificial Intelligence, Prof. Dr. Mohamed Yahia Al Mekki, Professor of Engineering, and several faculty members of the Faculty of Engineering.

Both parties discussed mutual cooperation possibilities in training fields, and participating in solving the technical issues, to which PUA can contribute in finding practical solutions. Thus, the parties agreed on the necessity of the optimal use of each party's available capabilities in a manner compliant with the state's strategy in terms of connecting the industrial institutions with production sites, and the Egyptian scientific and academic institutions to achieve the developmental objectives of the Egyptian society. To this end, both parties agreed on a protocol on cooperation that was signed by Prof. Dr. Mahmoud Mohy El-Din, as PUA President and Chem. Dr. Mosaad Attia Al Qasabi, as Chairman and Managing Director of Alexandria Specialty Petroleum Products Company (ASPPC).

#### 17.8.5 Cooperation Protocol between Pharos University and Arab Organization for Industrialization

Arab Organization for Industrialization visited Pharos University (P.U.A), and the delegation was headed by Major General /Ahmed Abdel Aziz – chairman of the board of directors of the electronics factory in the organization. The delegation included Dr. Essam Mansour – Advisor to the chairman of the board of directors of the electronics factory and Eng. Ashraf Khalil – head of the Human Resources sector. The two parties discussed the possibilities of cooperation in the fields of scientific research, training and participation in solving technical problems for the sake of carrying out research and patents and benefiting from the scientific and human capabilities at Pharos university and the Arab Organization for Industrialization.





## 17.9 – Cooperation For SDG 11

### 17.9.1 Pharos University in The First Egyptian Hackathon for Smart Cities

<https://www.pua.edu.eg/department-of-electrical-engineering-in-the-first-egyptian-hackathon-for-smart-cities/>

The Department of Electrical Engineering have participated in the activities of the first Egyptian Hackathon for Smart Cities at the national level. The event was held at Benha University from March 24 to March 26, 2022, under the patronage of His Excellency the Minister of Higher Education and Scientific Research, and in partnership with the Amazon Web Service.

Benha University, as the organizer of the event, announced that 478 teams representing 50 Egyptian public, private, and national universities applied to participate in the hackathon. The teams were later shortlisted to only 40 teams representing 25 universities.

The electrical engineering department team was chosen as the sole representative of Pharos University. The team includes five students from the fifth year, namely: Mohamed Abdel Azeem, Fayza Abdel Fattah Mohammad, Ahmed Khalil, Seif El-Din Mahmoud, Mohammad Ali Ahmed. Further, the project presented was supervised by Prof. Dr. Ahmed Abdullah. The team is also accompanied by Eng. Abdul Rahman Khaled, teaching assistant, as a supervisor.

### Participation of the Architectural Department in The Competition of Designing Kiosks at Al Azbakiya Park Within the Project of Developing the Garden

Within the framework of the government efforts in the development of the old Cairo area to revive, conserve and restore buildings, in addition to the development of urban areas, to serve pedestrians and transportation in their various forms that serve the society, and including the development of al Azbakiya Park, where the park occupies an urban site linked to most of the important squares of the city center.



To encourage the role of youth, the Department of Architecture at Pharos University in Alexandria has participated with six teams of different academic levels, where three of them were qualified for the finals within different universities in the keenness of the Department of Architecture at Pharos



University to develop the capabilities of students and participate effectively in community service.





17.9.2 The students participated in the following projects

#### PREPARING DETAILED PLANS FOR SLUMS IN ALEXANDRIA GOVERNMENT

Regarding the cooperation through technical and academic support for the urban planning and development system to improve the environment and achieve sustainable development goals and within the framework of fruitful cooperation between Pharos University and the Governorate of Alexandria to activate its pioneering role in the Alexandrian society, detailed plans were prepared for the two areas

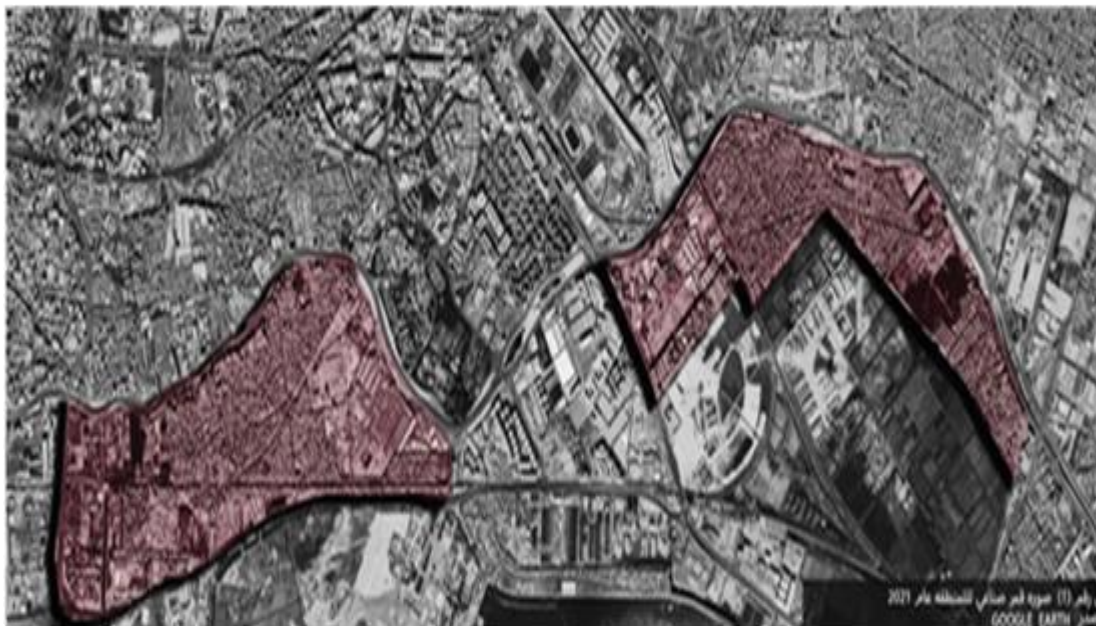



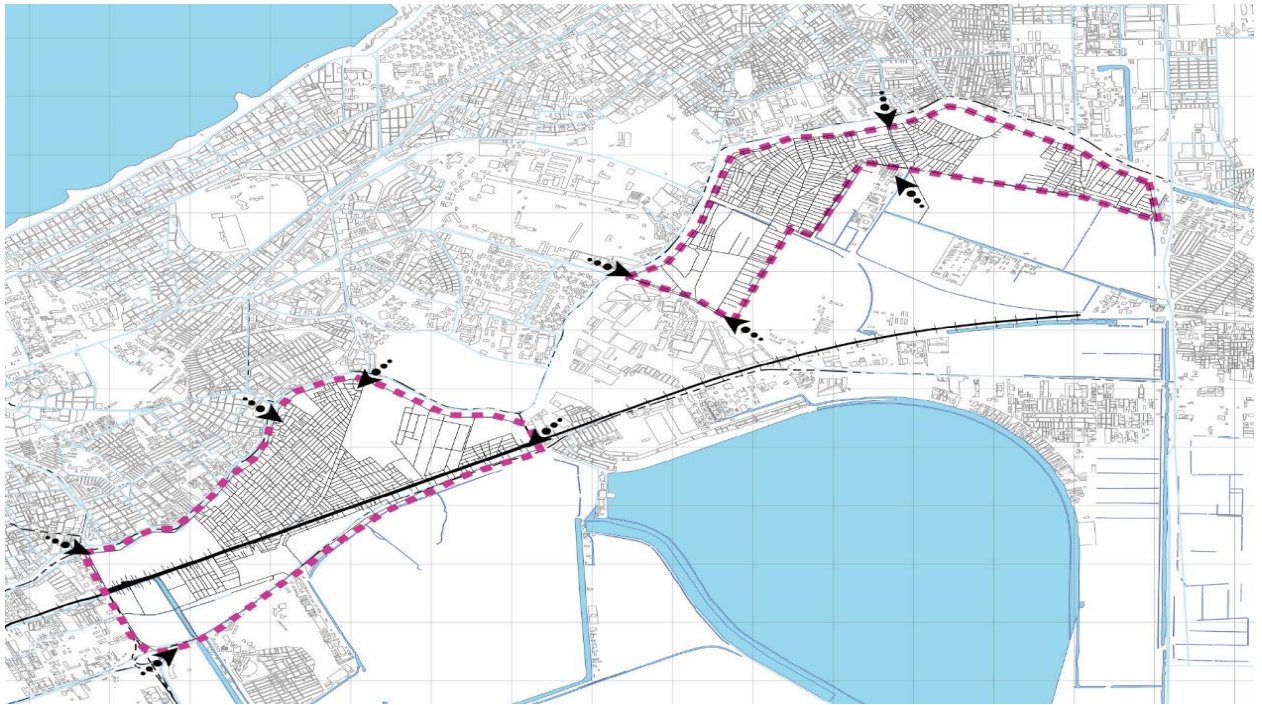





The Department of Architectural Engineering, which is in charge of implementing the plan assigned to it, executed and prepared a detailed report for the two areas and the future vision for them and presented the outputs of the proposed master plan suggesting a proposal for the development of these two areas through several development axes based on the future vision represented by a number of projects in the development of residential areas and lands, in a report containing 85 pages, in addition to 25 geographic information systems (GIS) maps.

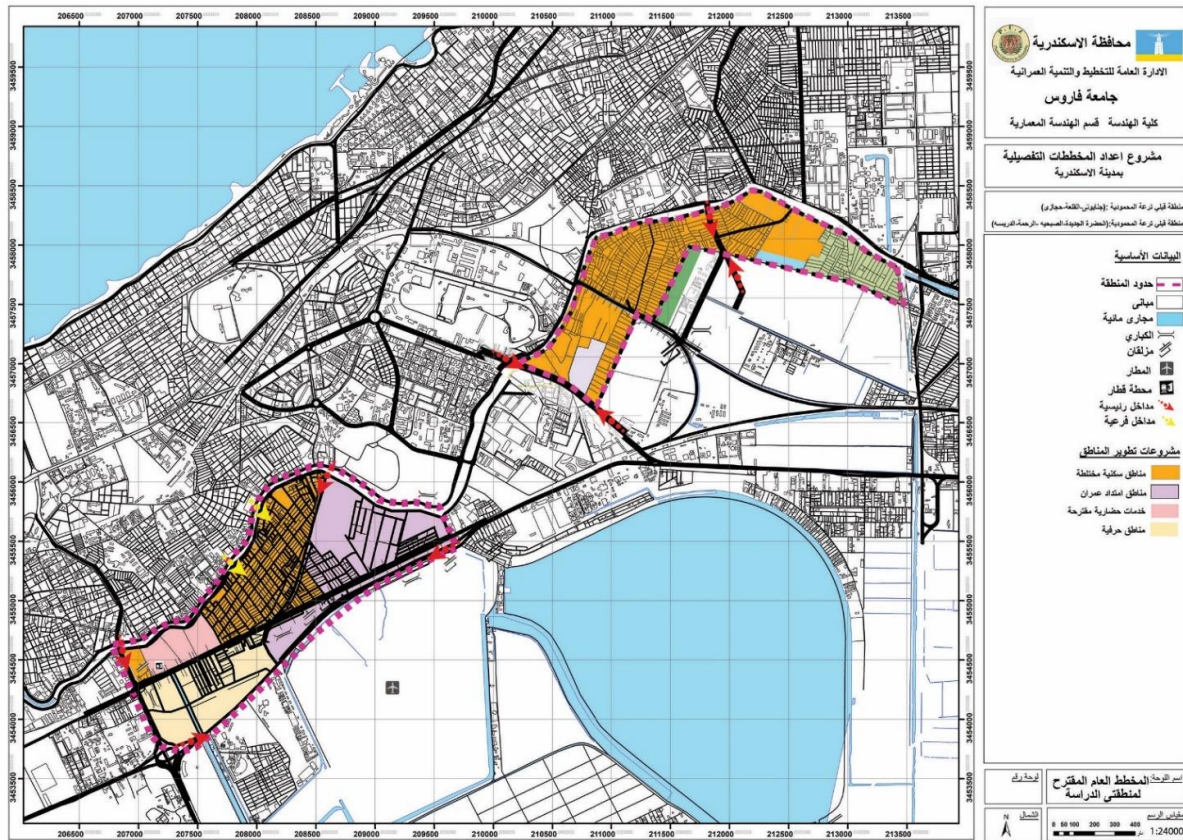



## Designing shaded waiting benches on campus

### ❖ Introduction:

Universities with open spaces need seating areas for students and visitors within the campus square. These settings must be shaded to provide protection and shelter to users from weather fluctuations, whether intense sunlight or rain especially after COVID19 pandemic regarding applying the precautionary measures and keeping the social distance. From here came the idea of the project where it presents a design proposal for a shaded waiting bench on Campus based on meeting the aesthetic appeal and functional needs to design a visual content befitting the identity of Pharos University in Alexandria.

### Project Summary:

#### ❖ Project Idea:

The project main idea lies in re-thinking the campus square that holds the CIB bank and all the university faculties, through introducing a design proposal of shaded waiting benches that provides protection and shelter to users from intense sunlight or rain, provided with several fixed side tables, which can be used in writing or for using students laptops provided with several electric sources where some students can join their on line lectures during their semesters.

#### ❖ Project Phases:

- Designing shaded waiting seating units in the campus square with a contemporary vision that provides protection and shelter to users from weather fluctuations, whether intense sunlight or rain instead of jamming under the faculties' entrance and atrium.
- Designing a complete integrated designed unit that is convenient for students to use within their online lecture's using their mobile phones or laptops or waiting between lectures, providing it with some fixed side tables and electrical sources to use.



- Introducing the specialization of Decor Department at the Faculty of Arts and Design, Pharos University to civil institutions.
- Enhance the capabilities of Egyptian youth in the field of specialty and relatively meeting the market needs.
- Encourage the student to progress in such competitions initiated to enhance the competitive ability within the field of environmental furniture design.

### ❖ Project Studies:

#### First: The theoretical and practical study within the course contents

The theoretical study of the project concerns studying the concept of the shaded design unit proposal in addition to studying the importance of furniture design to meet users' needs even relevant to aid local society and environment. This is addressed through main points:

- 1- The student's selection of the most convenient furniture design according to the vision and needs of the University Students and Visitors.
- 2- Developing the idea of the design through different sketches to reach the final idea selected.
- 3- Determining the specifications of the shaded waiting benches and the availability to repeat it on campus square within suitable circulations between them.
- 4- Preparing the structural drawings of the furniture design needed to perform the design proposal.

#### Second: The practical study through simulation and availability to perform the Design Proposal:

The practical study for the design proposal of the shaded waiting bench on campus

concerns:

- 1- Studying the suggested materials and fixation techniques of the design proposal on campus.



- 2- Mass planning for the campus student square relative to the shaded bench repetition.
- 3- Simulation, through computer aided programs by placing the designed proposal in the campus square with the planned vision to study its suitability on the university campus to suit the objectives of the project.

### **Towards Sustainable Development of Tourism Beaches: The case of El Mandarah Beach, Egypt**

This proposed project aims to develop an applicable, generic model and a practical action plan, which can be applied to all Alexandrian beaches and communities, to close the gap between the desired quality and the current state of how closely the management, employees, and visitors to these beaches adhere to the principles and international sustainability standards.

Furthermore, following an examination of the governorate of Alexandria's current sustainability initiatives, our aim is to educate local officials and the community on the concepts and principles of sustainability best practises, particularly during and after the corona virus pandemic, to raise awareness.

#### **Project Phases:**

In the various phases of the study, the project used diverse methodologies such as interviews, field visits, surveys, and workshops, as shown in the model.

The phases began with an examination of the current state of sustainable tourist development along the coast of Alexandria. Then, from the Alexandria seacoast, choose three beaches, Gleem, Anfhoshy, and El Mandara, one of which will be chosen based on criteria. Finally, adopting important steps to enhance sustainability along the Alexandria shore, such as the ones listed below:

- To facilitate the field visit, communicating with local authorities about the need for them to approve and provide access to allow the conduction of the field study smoothly, as well as the necessity for them to shine scientific light on it.
- Executing crucial and applicable criteria that express the study's pillars.
- By conducting the study survey, we are aiming for local community comments and opinions that focus on their intellectual background and convey those actual situations of the examined beaches.

➤ Following the revision of the local community perspective, the next step is to create an action plan that will make it simple for local governments to

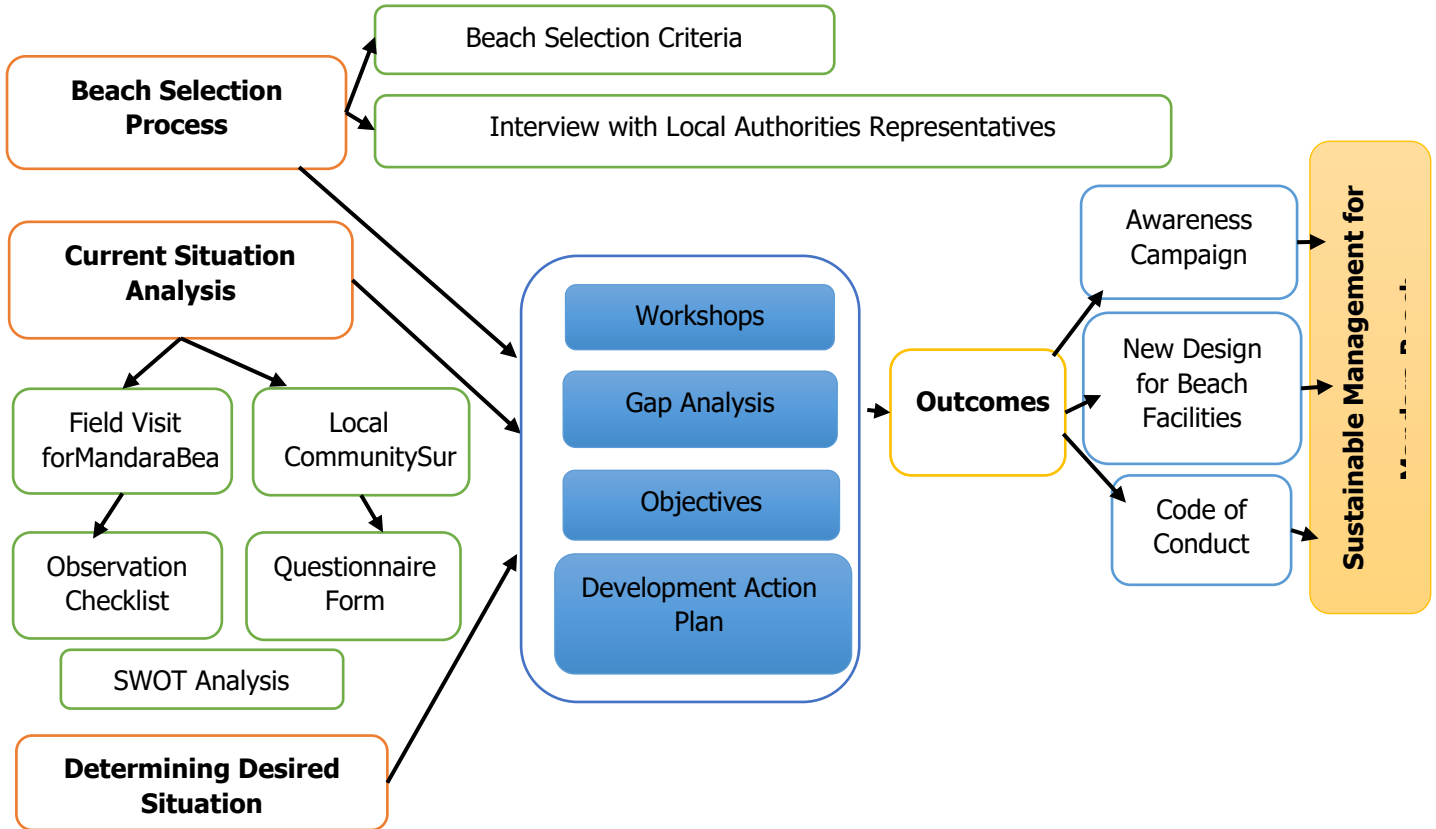

implement best practices.

From Abu Qir in the east to Al-Alamein and Sidi Abdul Rahman in the west, Alexandria beaches run for 140 kilometers along the Mediterranean Sea. The beaches of Alexandria are a popular tourist destination; each year, over one million local summer visitors and about five million inhabitants enjoy the summer season in Alexandria.





## 17.10 – Cooperation For SDG 13

### Pharos university organize a student's sustainable projects competition with cooperation with Birla Carbon Egypt

The faculty of Engineering organized the “Towards Sustainable Tomorrow” competition sponsored by Birla Carbon Egypt for the third year in a row. This was held on Tuesday, 28 July 2020. The competition aims to choose creative projects that serve sustainability. The value of 36000 LE was allocated for the awards of the first three places: 17000 LE for the 1<sup>st</sup> place, 12000 LE for the 2<sup>nd</sup> place and 7000 for the 3<sup>rd</sup> place. It is worth mentioning that 6 projects participated in this competition from [Electrical Engineering, Mechanical Engineering, Petrochemical Engineering Departments](#).

The electrical engineering project “IoT Approach for Sustainable Green Campus” won the 2<sup>nd</sup> place in the competition. It was submitted under the supervision of Dr. Mohammed Adb El Karim.

Petrochemical Engineering Department participated with 2 projects:

- “Synthesis of Ion Exchange Resins for Ammonia Removal Based on Waste Polymers” which was submitted under the supervision of Dr. Rania Farouk.
- “Recycling of Polyester Fabric Scraps” won 3<sup>rd</sup> place in the competition. It was submitted under the supervision of Dr. Ehsan Nafed.



Mechanical Engineering Department participated with 3 projects:

- “Design, Modeling and Performance Analysis of Solar Still” which was submitted under the supervision of Dr. Mohamed El Saied Youssef.
- “Design and Optimization of Network Solar” won the 1<sup>st</sup> place in the competition. It was submitted under the supervision of Dr. Mohamed El Naqib.
- “Home Scale Vertical Axis Wind Turbine (VAWT)” won the 2<sup>nd</sup> place in the competition. It was submitted under the supervision of Dr. Sameh Tawfik.



Pharos university participate in a conference discussing Climate Change effects on Alexandria, Organized by Alexandria university

<https://www.pua.edu.eg/climate-conference-2/>

<https://www.pua.edu.eg/media-and-climate-changes-seminar/>

A high-level delegation from Pharos University participated in the “Future of Alexandria and Climate Challenges” conference held at the Bibliotheca Alexandrina on Tuesday, March 29, 2022, which was co-sponsored by Pharos University. The delegation included Prof. Dr. Mahmoud Mohy El-Din, President of the University, Prof. Dr. Prof. Nourhan Fanaky, Vice-President for Education and Student Affairs, Prof. Dr. Prof. Ramadan Abu El-Ala, Vice President of Community Service & Environment Development Affairs, Prof. Dr. Boshra Salem, Dean of Postgraduate Studies and Research, and Prof. Dr. Ramadan Abdel Maksoud, Supervisor of the Department of Architecture, Faculty of Engineering, along with several university students. Further, the delegation members participated in the important discussions and recommendations produced from the sessions held in this regard.



Pharos university organizes a seminar on seminar on “Media and Climate Change in the Light of the Sustainable Development Goals” with participation of several local media experts

<https://www.pua.edu.eg/media-and-climate-changes-seminar/>

PUA’s Faculty of Mass Communication organized a seminar on “Media and Climate Change in the Light of the Sustainable Development Goals”. This seminar tackled the following topics:

1. Climate changes and how to adapt to them.
2. Urgent actions to address climate change.
3. Alexandria and the fate of disappearance.
4. Rising temperatures and their impact on coastal cities.
5. Sustainable development and climate fluctuations.
6. The role of media and social media in educating the public about climate change and their effects on all aspects of life.



Further, the seminar hosted a group of environment and media experts, namely: Dr. Mahmoud Bakr, Deputy Editor-in-Chief of Al-Ahram Weekly and Head of the Environment Department. Dr. Ramy Yacoub, United Nations Industrial Development Consultant and Director of the European Union and Earth Climate for Sustainable



Development Foundation's Climathon Egypt Project, Dr. Mamdouh Rashwan, Secretary-General of the Arab Union for Environmental Affairs and President of the Egyptian Youth Association for Development & Environment (YADE). Dr. Saber Mohammed Othman, Climate Change Expert and Chairman of the Board of Trustees of Climate Earth Climate for Sustainable Development Foundation's, Dr. Sameh Riyadh, Head of the Environmental Affairs Authority in Alexandria Governorate. Prof. Hassan Baraka, Assistant Editor-in-Chief and Environmental official at Al-Akhbar Newspaper. Prof. Fawzy Abdel Halim, former Editor-in-Chief and Head of Environment Department of Al-Ahram Newspaper. The seminar aimed to educate students about the climate change crisis and its effects on the future of upcoming generations.

This seminar was moderated by Dr. Mahmoud Bakr, Deputy Editor-in-Chief of Al-Ahram Weekly and Head of the Environment Department at Al-Ahram. The guests presented several visions on different topics.

### **Students' community service projects**

The community service project is an annual curricular project for all students. The project is aiming at helping the community by providing services that address sustainable development goals. Each scientific department designs a project for a group of students. The projects are evaluated by a general committee every year for the winning projects

<https://www.pua.edu.eg/60116/>

the student projects for 2020-2021 were summarized in this report



## 17.11 – Cooperation For SDG 16

For SDG 16 the students participated in the following project

How rightful it is for countries to force it's citizens to take the vaccine

- The first aspect: Social responsibility

We launched an awareness campaign about the dangers of the virus and the necessity of receiving the vaccine, as well as offering a reward to those who are about to receive the vaccine. We named our reward card (Coronopoly) as the inspiration was derived from the game (Monopoly), and the campaign is called (Get Out of Isolation).

- The second aspect: The legal role

The university is intervening in the lawsuit filed before the Administrative Court against the Prime Minister, where several plaintiffs are clearly impacted by the requirement to submit a certificate of vaccination when they enter their workplaces.

- The third aspect: The medical aspect

In our research, we referred to documented opinions of medical professionals in this matter, headed by the World Health Organization.

We will present this study by presenting two opposing opinions, each with its own arguments and proofs.

### ❖ Recommendations

At the end of our study, and after confirming the different opinions presented by the two parties, we conclude with the following recommendations:

**First:** We demand that Pharos University accept joining the lawsuit filed with the prepared defense memorandum.

**Second:** We ask the state to provide an advantage for the elderly, who are – certainly – fertile ground for the virus and are not obligated in any way to take the vaccine.

We have tried in every way possible during our campaign to provide integrated medical teams to go to the homes of the elderly to give them the vaccine, but it



was not possible for us to do so because of the strict procedures the state has set up regarding this matter, represented by the Egyptian Ministry of Health.

**Third:** Launching an intensive awareness campaign for the age group from 15 to 18, who had the opportunity to be vaccinated from the 7<sup>th</sup> November.





## 17.12 – International Cooperation and Partnerships for Sustainable Development

International Partnerships (MOUs): Pharos University established international relations with the following renowned universities and research centers:

Faculty	International Institute	Contributing to SDG
Pharmacy	Université de Picardie Jules Verne UPJV	SDG 3
Dentistry, Pharmacy and Business	The University of Naples Federico II, Italy	
	Pharmacy	Aston University, Birmingham, UK
Kingston University, London, UK		
Leipzig, Germany		
Engineering	Royal Institute of Technology KTH – Sweden	SDG 6, SDG 7, SDG 11, SDG 12, SDG 13
	RWTH Aachen	SDG 6, SDG 7, SDG 11, SDG 12, SDG 13
Allied Medical sciences	FH Campus Wien	SDG3
Physical Therapy,	Goethe' University , Frankfurt, Germany	SDG3



Faculty	International Institute	Contributing to SDG
Humanities (business and entrepreneurship), and engineering	Heilbronn University HHN Germany	SDG 6, SDG 7, SDG 8, SDG 11, SDG 12, SDG 13
	Tomas Bata University (TBU), Czech Republic	SDG 6, SDG 7, SDG 11, SDG 12, SDG 13
	University of Alabama in Birmingham, USA	SDG 6, SDG 7, SDG 11, SDG 12, SDG 13
	Hunan Agriculture University - China	SDG 6, SDG 7, SDG 11, SDG 12, SDG 13
	Belarusian State University	SDG 6, SDG 7, SDG 11, SDG 12, SDG 13
	Universidad de Sevilla	SDG 7, SDG 11
Tourism	City University- Malaysia	SDG 8, SDG 9, SDG 11
	Ulster University	SDG 8, SDG 9, SDG 11
Humanities (business and entrepreneurship),	JAMK University of Applied Sciences, Finland	SDG 8, SDG 9, SDG 11
Humanities (Tourism and language)	Technological University Dublin (TU Dublin), Ireland	SDG 8
	Tomas Bata University (TBU), Czech Republic	SDG 8
	TOI-OHOMAI	SDG 8
Humanities (Law)	Sciences Po Lille - France	SDG 16
Humanities (Art and design)	Kingston University, London, UK	SDG 11
Pharmacy	Aston University, Birmingham, UK	SDG 3
Physical Therapy, Applied Medical	University of Oradea-Romania	SDG 3



Faculty	International Institute	Contributing to SDG
Humanities (Optometry)	Lincoln University College, Malaysia	SDG 9, SDG 11
	University of Missouri–Kansas City (UMKC), USA	SDG 9, SDG 11
Humanities (Mass communication)	East Carolina University, USA	SDG 17
Humanities (Languages), Tourism	The British Council	SDG 17
	Norwich Institute for Language Education, UK	SDG 17
	Universidad De Castilla- La Mancha-Spain	SDG 5, SDG 17
	University of Naples Federico	SDG 5, SDG 17
	Cambridge- ESOL (English Language Centre (ELC)	SDG 5, SDG 17
	Beijing Languages and Culture University (BLCU), China	SDG 5, SDG 17
	Trinity College	SDG 17
	Guangdong University of Foreign studies	SDG 5, SDG 17
	University of A Coruña	SDG 5, SDG 17
	AMIDEAST	SDG 5, SDG 17
University of Leicester	SDG 5, SDG 17	



17.13 – General MOUs

Agence Universitaire Francophonique	
Salamanca University, Spain	
Institute Of International Education (Lotus Program)	
USAID projects	
Aristotle University of Thessaloniki, Greece	
University of Eastern Finland UEF	



University Senghor, Alexandria	 Université Senghor
Durban University of Technology	





## 17.14 – Conferences

List of conferences that were held in Pharos university

Faculty	Date	Conference	Related SDG
Pharmacy and Drug Manufacturing	March 11-12, 2020	2nd PUA International Conference - Multidisciplinary Approaches in Pharmaceutical Sciences ICMAPS / 2020	SDG 3
Financial and Administrative Sciences	April 4-8, 2020	Sixth International Conference of Business Innovation & Economic Sustainability Challenges - TU Dublin	SDG 8
Engineering	March 1-2, 2022	The Third International Conference on New Trends for Sustainable Energy, ICNTSE 2021 (ONLINE) - From Waste To Energy	SDG 7
Languages and Translation	March 11-12, 2022	Translation and Teaching English: Challenges and Perspectives - University College Dublin	SDG 4
Pharmacy and Drug Manufacturing	May 14, 2022	3rd PUA International Conference in Pharmaceutical Sciences	SDG 3
Applied Health Sciences Technology	May 22, 2022	Nutrition and health and disease the update Dietetic Practice	SDG 3



### Third International Conference on New Trends in Sustainable Energy (ICNTSE-2021) online

<https://www.pua.edu.eg/third-international-conference-on-new-trends-in-sustainable-energy-icntse-2021-online/>

PUA's Faculty of Engineering organizes the Third International Conference on New Trends in Sustainable Energy (ICNTSE-2021) on 1-2 March 2022 via online conference. It is also worth mentioning that the Journal of King Saud University – Engineering Sciences (JKSUES) will publish a special edition for a selected group of the conference's research, which meet the journal's publishing requirements.



### The Faculty of Languages and Translation held an international conference in collaboration with Trinity College, Dublin University

The Faculty of Languages and Translation held a 2-day international conference in collaboration with Trinity College, Dublin University entitled "Translation and Teaching: Challenges and Perspectives". The conference had great feedback from 140 attendees from all around Egypt as well as attendees



from Trinity College virtually. The conference dealt with a variety of topics on invitation methods of teaching and recent research on Translation. All abstracts were published in the conference procedures as well as keynote speakers' abstracts. The conference held parallel sessions to cover a variety of topics. The attendees were thrilled by the organization, topics, and networking vibes.



Thank you note to all our sponsors: Capital Professional Development, American Council Egypt, IDP, and ECL Cambridge. The conference help SDG4

## Faculty of pharmacy 2<sup>nd</sup> international conference 11<sup>th</sup> -12<sup>th</sup>, March 2020

<http://beta.pua.edu.eg/icmaps/>

The Pharmaceutical sciences are a group of interdisciplinary areas involved with the design, action, delivery, disposition, and use of drugs aiming to uplift the quality of life and public health. Bearing this mission, Faculty of Pharmacy and Drug Manufacturing, Pharos University in Alexandria, Egypt has the pleasure to cordially invite you to join the Second PUA International Conference on Multidisciplinary Approaches in Pharmaceutical Sciences, taking place on March 11-12, 2020, at Pharos University in Alexandria, Egypt.

The goal of the conference is to bring together pharmaceutical groups of national and international academics, researchers, community and industrial pharmacists and clinicians to have an interchangeable break- through ideas related to the most recent advances in pharmaceutical technologies. Challenges and opportunities will be discussed through exchange of ideas and collaboration



## 17.15 – Partnerships for Sustainability

### Activities with Africa in the field of Sustainable Development

Pharos university is keen to have planned actions to recruit students/staff/faculty from under-represented group particularly Africa. Recently the university took steps in the following activities:

#### Pharos University in Alexandria organizes a virtual “Design thinking and Ideation camp” through E-Club

PUA in cooperation with the African Union and the Egyptian Academy of Scientific Research and Technology, the camp targets students, and graduates of PUA and African Union universities. The camp is held from 26-29 July 2021 aiming at motivating African youth towards “Social Entrepreneurship” to trigger innovative ideas that serve the goals of development and sustainability in the African societies.

<https://www.pua.edu.eg/intra-africa-2063-competition/>

In the same context, Pharos University in Alexandria organizes a virtual “Design thinking and Ideation camp” through Eclub PUA in cooperation with the African Union and the Egyptian Academy of Scientific Research and Technology, the camp targets students, and graduates of PUA and African Union universities.

The poster for the Intra-Africa 2063 Competition features a map of Africa in the background. At the top, it lists logos for E-Club, PUA, ASRT, and AAU. The main title is "Intra-Africa 2063 Competition" with the subtitle "virtual workshops hand in hand by PUA, ASRT & AAU" and dates "26/7 - 29/7/2021". It specifies time zones: GMT, Egypt, Nigerian, Southern African, and East African. Key features include "Free Event - Free Registration - Attendance Certificate - Held in English" and a registration deadline of 13/7. The objectives are to create innovative scientific ideas or research projects to serve African societies. The theme is "The Establishment of an AFRICAN Digital, Distance Learning University Social ENTREPRENEURSHIP". It mentions specialized trainers and a judging panel. Fields of social entrepreneurship include illness, poverty, illiteracy, environmental destruction, and human rights. Prizes include a Platinum prize (Language and Soft skills courses), a Golden prize (Soft skills course), and a Silver prize (Traditional Egyptian Kitchen course or Dubbing and Voice over course). A registration link is provided at the bottom.

The camp is held from 26-29 July 2021 aiming at motivating African youth towards “Social Entrepreneurship” to trigger innovative ideas that serve the goals of development and sustainability in the African societies.

<https://www.pua.edu.eg/%d9%85%d8%a8%d8%a7%d8%af%d8%b1%d8%a9-%d8%aa%d9%81%d8%b9%d9%8a%d9%84-%d8%aa%d8%b7%d9%84%d8%b9%d8%a7%d8%aa->



<https://www.pua.edu.eg/pua-participates-in-the-15th-general-conference-of-the-association-of-african-universities/>

## PUA participates in the 15th General Conference of the Association of African Universities “ “The Future of African Higher Education in Africa”

<https://www.pua.edu.eg/pua-participates-in-the-15th-general-conference-of-the-association-of-african-universities/>

Pharos University in Alexandria (PUA) has participated in the 15th General Conference of the Association of African Universities that held virtually from 5-8 July 2021 hosted by. Dr. Khaled Abdel Ghaffar, Minister of Higher Education and Scientific Research. His excellency has participated a speech and on Monday 5th of July in the 15th Conference of African University Leaders, organized by the Federation of African Universities via video conferencing technology.

At the beginning of his speech, the Minister expressed his happiness to participate in the conference held under the patronage of the Ghanaian President, pointing out the importance of working to bring about a qualitative move in higher education in Africa, to promote social and economic growth, by creating a better environment for higher education and scientific research and building modern systems of science, technology, and innovation.

The coordinator of African relations of PUA, Dr. Nourhan Al-Haridi, participated in the various sessions of the conference activities as a representative of the university, based on the support of Pharos University in Alexandria and its role in developing and raising the efficiency of higher education and scientific research in Africa

## Pharos University Participated in Africa Higher Education Webinar

The Webinar entitled “Towards Linked Africa Higher Education: Windows of Opportunities” organized under the supervision of the Association of African Universities’ North Africa Regional Office “AAU-NARO”. This was held on Wednesday, 17 March 2021.

<https://www.pua.edu.eg/pharos-university-participated-in-africa-higher-education-webinar/>

It is worth mentioning that more than 20 African universities participated in the webinar including Pharos University which was represented by Prof. Boshra





Salem, Dean of Postgraduate Studies and Research in Pharos University and Dr. Mennatallah Gowayed, the PUA International Relations Coordinator.

During the webinar, on behalf of PUA president Prof. Boshra Salem gave a speech to representatives of “NARO” and participating universities and thanked “NARO” for inviting Pharos University to be a part of activities to mark NARO’s two years’ anniversary. This was followed by a presentation by Dr. Mennatallah Gowayed on PUA international relations specially with the Corona circumstances. It is worth mentioning that Pharos University is the only Egyptian university presented the topic of internationalization and international relations.

[Pharos University joins the Association of African Universities](https://www.pua.edu.eg/pharos-university-joins-the-association-of-african-universities/)

<https://www.pua.edu.eg/pharos-university-joins-the-association-of-african-universities/>

**Cooperation with KTH university in the field of quality education**

<https://www.pua.edu.eg/pharos-university-organized-meetings-with-kth-royal-institute-of-technology/>

The International Relations Department organized many Zoom meetings between the academic staff of the Faculty of Engineering and KTH Royal Institute of Technology on 22-23 March, in order to track engineering students’ exams. During these meetings, the exams’ models and quality standards were discussed. It is worth mentioning that the teaching schedule has been approved for the next semester (spring 2020/2021).





## Cooperation Project between University of Wolverhampton of UK and Pharos University in Alexandria

<https://www.pua.edu.eg/cooperation-between-wolverhampton-of-uk-and-pharos-university/>

Joint Cooperation Project between University of Wolverhampton of UK and Pharos University in Alexandria

Advancing apprenticeship learning in Trans-National Education (TNE)

the Faculty of Engineering and the Construction Engineering and Management Department were honored to receive and organize the scientific forum entitled "Advancing apprenticeship learning in Trans-National Education (TNE) as one of the activities of the joint project between Pharos University in Alexandria and the

University of Wolverhampton and funded by the British Council from the 25th to the 28th of July 2022 where a team from the University of Wolverhampton visited Pharos University in Alexandria and discussed the ways of Cooperation between in the presence of a selection of faculty members, representatives of the Syndicate of the Egyptian Engineers and experts and specialists from industry.





## Cooperation Protocol with TÜV AUSTRIA

For supporting the academic study of the faculty students, providing them with practical and field experiences, and linking the curricula with industrial fields to achieve the sought integration, Prof. Dr. Mohamed Gaber Abou Ali, Dean of the Faculty of Engineering along with a group of the Faculty professors welcomed Mr. Osama El-Sayed Ibrahim, Regional Director of TÜV AUSTRIA, on Wednesday, January 26, 2022. The meeting included the signing of a cooperation protocol between PUA's Faculty of Engineering and TÜV Austria.



This protocol included providing training opportunities and specialized workshops for the faculty students, providing experienced staff to supervise the students' research and projects at the faculty, which would provide solutions to some of the industry's problems. In a similar context, the faculty organizes training programs, workshops, conferences, and seminars for the company's employees. It also provides academic consultations considering the experience of its professors to solve some of the company's problems, which requires conducting research and studies in this regard.

### **Faculty Of Pharmacy Organizes two workshops**

The faculty of Pharmacy and Drug Manufacturing, Organized two workshops on 9-10 March 2020 from 9 am to 4 pm. The first workshop is on "How to Implement Flipped Classroom Approach in University Courses" and delivered by Prof. Markku Saarelainen, a Professor of Physics at University of Eastern Finland (UEF) and a Professor of Practice at Tampere University (TAU) in Finland. Meanwhile, the second workshop which is about "Synthesis, Processing, Characterization and Functional Validation of Inorganic Nanomaterials for Bio-applications", is delivered by Prof. Muhammet Toprak, a Professor of Materials Chemistry, Nanochemistry Research Group in the KTH -Sweden.



## An EU Funded project with six regional and international universities for sustainable development and preservation of heritage

<https://www.pua.edu.eg/tourism-and-hotel-management/sustainability-concept-applications/fund-projects/>

The Faculty of Tourism and Hotel Management heads a funded project by the European Union, in partnership

Université de Malte

Leeds Beckett University- United Kingdom o Middle East University – Jordan

Yarmouk University – Jordan o Suez Canal University

Fayoum University

The proposed project under the title “Cultural Heritage Virtual Education System” (CHVEs) aims to modernize and improve the educational process in the field of tourism and cultural heritage sciences in the faculties and institutes of higher education in Egypt, through the development of international scientific cooperation and the transfer of knowledge. This project is considered of great value and importance regarding the issue of supporting the process of sustainable development and the preservation of the cultural and urban heritage of countries.



## 17.16 – International Mobilities Contributing to Different SDGs

Name	Title	Faculty	Host University	Year	SDG
Mohmaed Elkoly	Lecturer	Engineering	KTH, Sweden	2022	SDG 9
Alaa Mahmoud Khalil	Lecturer	Engineering	KTH, Sweden	2022	SDG 9
Tamer Mohamed	Lecturer	Tourism and hotel management	Universidad de coruña, Spain	2022	SDG 13
Lamiaa Ibrahim Fathy	Assoc. Professor	Tourism and hotel management	JAMK University Finland	2021	SDG 13
Eslam Ibrahim Fathy	Assoc. Professor	Tourism and hotel management	JAMK University Finland	2021	SDG 13
Rasha Elbyaa	Professor	Pharmacy	Eastern Finland , Finland	2022	SDG 3, SDG 4
Gihan Labib	Assoc. Professor	Pharmacy	Eastern Finland , Finland	2022	SDG 3, SDG 4
Menna gwaed	Assoc. Professor	Pharmacy	Eastern Finland , Finland	2022	SDG 3, SDG 4
Rewan Medhat	Demonstrator	Pharmacy	Eastern Finland , Finland	2022	SDG 3, SDG 4
Omnia Ashraf	Demonstrator	Pharmacy	Eastern Finland , Finland	2022	SDG 3, SDG 4
Rania Raof	Lecturer	Art and design	Aristotle University of Thessaloniki, Greece	2022	SDG 11
Nada Kamel	Lecturer	Art and design	Aristotle University of Thessaloniki, Greece	2022	SDG 11





Name	Title	Faculty	Host University	Year	SDG
Mohamed Osama	Assistant lecturer	Art and design	Aristotle University of Thessaloniki, Greece	2022	SDG 11
Ireni Rober	Assistant Lecturer	Financial and Administrative Sciences	TU, Dublin	2020	SDG 8
Omnia Mohamed	Assistant Lecturer	Financial and Administrative Sciences	TU, Dublin	2020	SDG 8